

DVD Player

DVP3256K

Service

DVP3256K/93

Service



Service

Service Manual

TABLE OF CONTENTS

	Page
Technical Specifications.....	1-2
. Safety Instruction, Warning & Notes.....	1-3
. Mechanical and Dismantling Instructions.....	2-1
. Region Code, Software Version & Upgrades.....	3-1
. Trouble Shooting Chart.....	4-1
. Wiring Diagram.....	5-1
. Electrical Diagrams and Print-layouts.....	6-1
. Set Mechanical Exploded view & Part list.....	7-1
. Revision List.....	8-1

©Copyright 2008 Philips Consumer Electronics B.V. Eindhoven, The Netherlands
All rights reserved. No part of this publication may be reproduced, stored in a retrieval system or transmitted, in any form or by any means, electronic, mechanical, photocopying, or otherwise without the prior permission of Philips.

**CLASS 1
LASER PRODUCT**

Published by KC-0804 Service Audio Printed in The Netherlands Subject to modification

 3139 785 33420

Version 1.0

PHILIPS

Specifications

TV STANDARD

	(PAL/50Hz)	(NTSC/60Hz)
Number of lines	625	525
Playback	Multistandard (PAL/NTSC)	

VIDEO PERFORMANCE

Video DAC	12 bit, 108 MHz
Y Pb Pr	0.7 Vpp ~ 75 ohm
Video Output	1 Vpp ~ 75 ohm

VIDEO FORMAT

Digital Compression	MPEG 2 for DVD, SVCD MPEG 1 for VCD DivX®
---------------------	---

	50 Hz	60 Hz
Horiz. resolution	720 pixels	720 pixels
Vertical resolution	576 lines	480 lines

	50 Hz	60 Hz
Horiz. resolution	352 pixels	352 pixels
Vertical resolution	288 lines	240 lines

AUDIO FORMAT

Digital	MPEG/ AC-3/ PCM	compressed Digital 16, 20, 24 bits fs, 44.1, 48, 96 kHz
	MP3 (ISO 9660)	96, 112, 128, 256 kbps & variable bit rate fs, 32, 44.1, 48 kHz

Analog Sound Stereo
Dolby Surround compatible downmix from Dolby
Digital multi-channel sound

AUDIO PERFORMANCE

DA Converter	24 bit, 192 kHz
DVD	fs 96 kHz 4 Hz - 44 kHz
	fs 48 kHz 4 Hz - 22 kHz
SVCD	fs 48 kHz 4 Hz - 22 kHz
	fs 44.1kHz 4 Hz - 20 kHz
CD/VCD	fs 44.1kHz 4 Hz - 20 kHz
Signal-Noise (1kHz)	> 90 dB
Dynamic range(1kHz)	> 80 dB
Crosstalk (1kHz)	> 70 dB
Distortion/noise (1kHz)	> 65 dB
MPEG MP3	MPEG Audio L3

CONNECTIONS

Y Pb Pr Output	Cinch 3x
Video Output	Cinch (yellow)
Audio Output(Front L+R)	Cinch (white/red)
Digital Output	1 coaxial IEC60958 for CDDA / LPCM IEC61937 for MPEG 1/2, Dolby Digital

5.1 Channel Analog Output

Audio Front L+R	Cinch (white/red)
Audio Rear L+R	Cinch (white/red)
Audio Center	Cinch (blue)
Audio Subwoofer	Cinch (black)

CABINET

Dimensions (w x h x d)	360 x 37x 209 mm
Weight	Approximately 2 kg

POWER CONSUMPTION

Power Supply Rating	110 V – 240 V; 50/60 Hz
Power consumption	< 10 W
Power consumption in Standby mode	< 1 W

Specifications are subject to change without prior notice.

Safety instruction, Warning & Notes

Safety instruction

1. General safety

Safety regulations require that during a repair:

- . Connect the unit to the mains via an isolation transformer.
- . Replace safety components indicated by the symbol , only by components identical to the original ones. Any other component substitution (other than original type) may increase risk of fire or electrical shock hazard.

Safety regulations require that after a repair, you must return the unit in its original condition. Pay, in particular, attention to the following points:

- . Route the wires/cables correctly, and fix them with the mounted cable clamps.
- . Check the insulation of the mains lead for external damage.
- . Check the electrical DC resistance between the mains plug and the secondary side:
 - 1) Unplug the mains cord, and connect a wire between the two pins of the mains plug.
 - 2) Set the mains switch the "on" position (keep the mains cord unplug).
 - 3) Measure the resistance value between the mains plug and the front panel, controls, and chassis bottom.
 - 4) Repair or correct unit when the resistance measurement is less than 1M Ω .
 - 5) Verify this, before you return the unit to the customer/user (ref. UL-standard no. 1492).
 - 6) Switch the unit "off", and remove the wire between the two pins of the mains plug.

2.Laser safety

This unit employs a laser. Only qualified service personnel may remove the cover, or attempt to service this device (due to possible eye injury).

Laser device unit

Type	: Semiconductor laser GaAlAs
Wavelength	: 650nm (DVD) : 780nm (VCD/CD)
Output power	: 7mW (DVD) : 10mW (DVD /CD)

Beam divergence: 60 degree

Note: Use of controls or adjustments or performance of procedure other than those specified herein, may result in hazardous radiation exposure. Avoid direct exposure to beam.

Warning

1. General

. All ICs and many other semiconductors are susceptible to electrostatic discharges (ESD). Careless handling during repair can reduce life drastically. Make sure that, during repair, you are at the same potential as the mass of the set by a wristband with resistance. Keep components and tools at this same potential. Available ESD protection equipment:

- 1) Complete kit ESD3 (small tablemat, wristband, connection box, extension cable and earth cable) 4822 310 10671.
- 2) Wristband tester 4822 344 13999.

. Be careful during measurements in the live voltage section. The primary side of the power supply, including the heat sink, carries live mains voltage when you connect the player to the mains (even when the player is "off!"). It is possible to touch copper tracks and/or components in this unshielded primary area, when you service the player. Service personnel must take precautions to prevent touching this area or components in this area. A "lighting stroke" and a stripe-marked printing on the printed wiring board, indicate the primary side of the power supply.

. Never replace modules, or components, while the unit is "on".

2. Laser

- . The use of optical instruments with this product, will increase eye hazard.
- . Only qualified service personnel may remove the cover or attempt to service this device, due to possible eye injury.
- . Repair handling should take place as much as possible with a disc loaded inside the player.
- . Text below is placed inside the unit, on the laser cover shield:

CAUTION: VISIBLE AND INVISIBLE LASER RADIATION WHEN OPEN, AVOID EXPOSURE TO BEAM.

Notes: Manufactured under licence from Dolby Laboratories. The double-D symbol is trademarks of Dolby Laboratories, Inc. All rights reserved.

Notes

Lead-Free requirement for service

INDENTIFICATION:

Regardless of special logo (not always indicated) 

One must treat all sets from 1.1.2005 onwards, according next rules.

Important note: In fact also products a little older can also be treated in this way as long as you avoid mixing solder-alloys (leaded/ lead-free). So best to always use SAC305 and the higher temperatures belong to this.

Due to lead-free technology some rules have to be respected by the workshop during a repair:

- Use only lead-free solder alloy Philips SAC305 with order code 0622 149 00106. If lead-free solder-paste is required, please contact the manufacturer of your solder-equipment. In general use of solder-paste within workshops should be avoided because paste is not easy to store and to handle.
 - Use only adequate solder tools applicable for lead-free solder alloy. The solder tool must be able
 - To reach at least a solder-temperature of 400°C,
 - To stabilize the adjusted temperature at the solder-tip
 - To exchange solder-tips for different applications.
 - Adjust your solder tool so that a temperature around 360°C – 380°C is reached and stabilized at the solder joint. Heating-time of the solder-joint should not exceed ~ 4 sec. Avoid temperatures above 400°C otherwise wear-out of tips will rise drastically and flux-fluid will be destroyed. To avoid wear-out of tips switch off un-used equipment, or reduce heat.
 - Mix of lead-free solder alloy / parts with leaded solder alloy / parts is possible but PHILIPS recommends strongly to avoid mixed solder alloy types (leaded and lead-free). If one cannot avoid, clean carefully the solder-joint from old solder alloy and re-solder with new solder alloy (SAC305).
- Use only original spare-parts listed in the Service-Manuals. Not listed standard-material (commodities) has to be purchased at external companies.
 - Special information for BGA-ICs:
 - always use the 12nc-recognizable soldering temperature profile of the specific BGA (for de-soldering always use highest lead-free temperature profile, in case of doubt)
 - lead free BGA-ICs will be delivered in so-called 'dry-packaging' (sealed pack including a silica gel pack) to protect the IC against moisture. After opening, dependent of MSL-level seen on indicator-label in the bag, the BGA-IC possibly still has to be baked dry. This will be communicated via AYS-website.
Do not re-use BGAs at all.
 - For sets produced before 1.1.2005, containing leaded soldering-tin and components, all needed spare-parts will be available till the end of the service-period. For repair of such sets nothing changes.
 - On our website:
 - www.atyourservice.ce.Philips.com

You find more information to:

BGA-de-/soldering (+ baking instructions)
Heating-profiles of BGAs and other ICs used in Philips-sets

You will find this and more technical information within the "magazine", chapter "workshop news".
For additional questions please contact your local repair-helpdesk.

Mechanical and Dismantling Instructions

Dismantling Instruction

The following guidelines show how to dismantle the player.

Step1: Remove 5 screws around the Top Cover, and then remove the Top Cover (Figure 1).

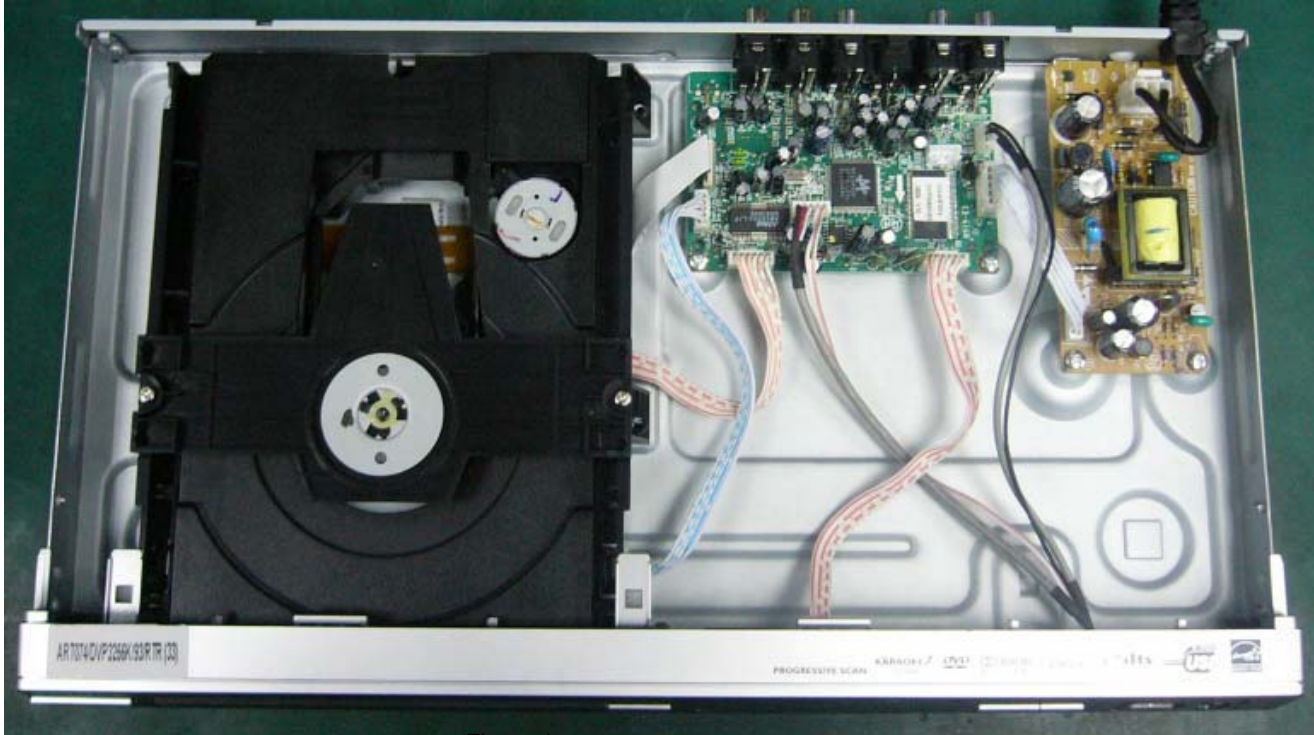

Figure 1

Step2: If it is necessary to dismantle Loader or Front Panel, the Front door should be removed first. (Figure 2)

Note: Make sure to operate gently otherwise the guider would be damaged.



Please kindly note that dismantle the front door assembly carefully to avoid damage tray and the front door.

Figure 2

Mechanical and Dismantling Instructions

Dismantling Instruction

Step3: If the tray can't open in normal way, you can make it through the instruction as below (Figure 3).
Note: Make sure to operate gently otherwise the guider would be damaged.

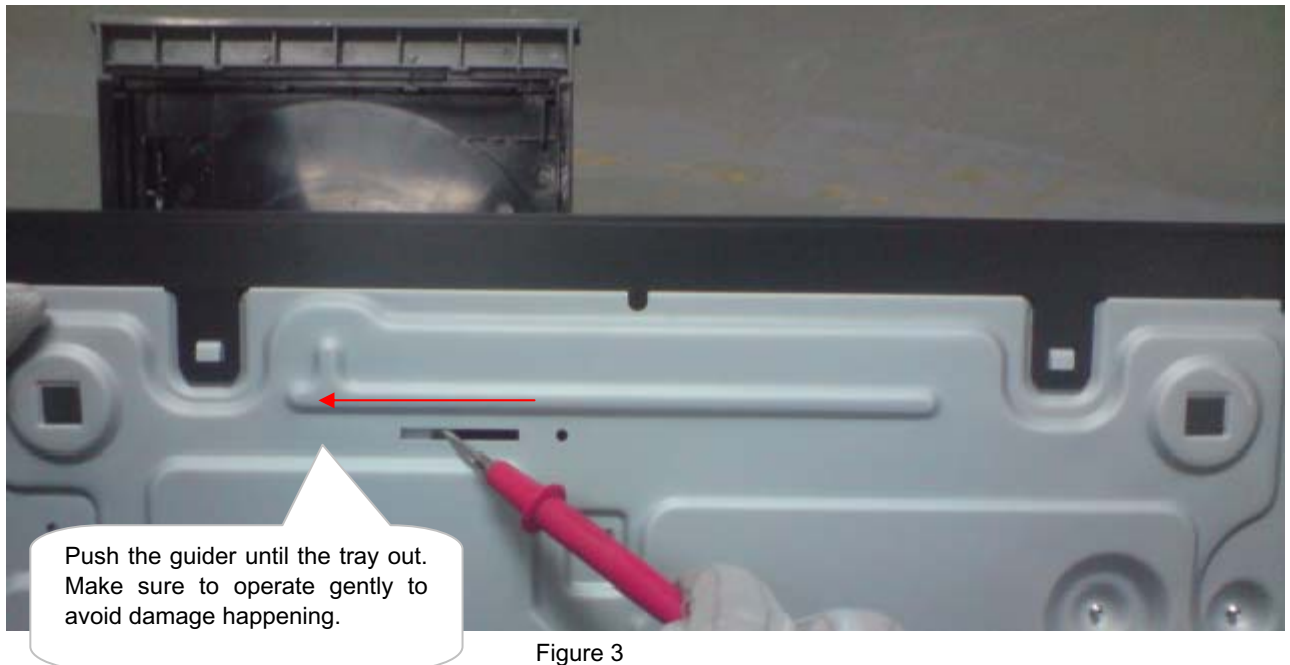

Step4: Dismantling Front Panel, disconnect the connectors (XP5, XP6, XP7), then release the snaps on the both sides of Front Panel and bottom cabinet, then gently pull the Panel out from the set. (Figure 4 & 5)

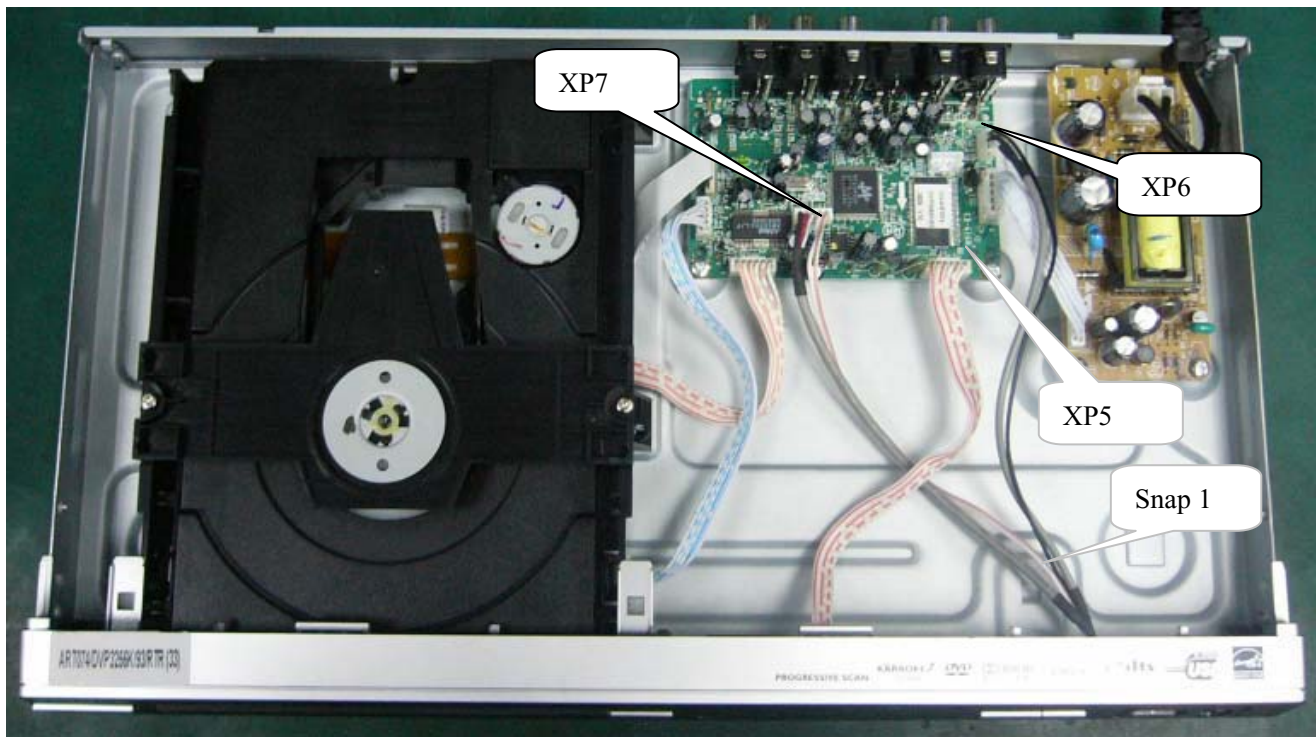

Mechanical and Dismantling Instructions

Dismantling Instruction

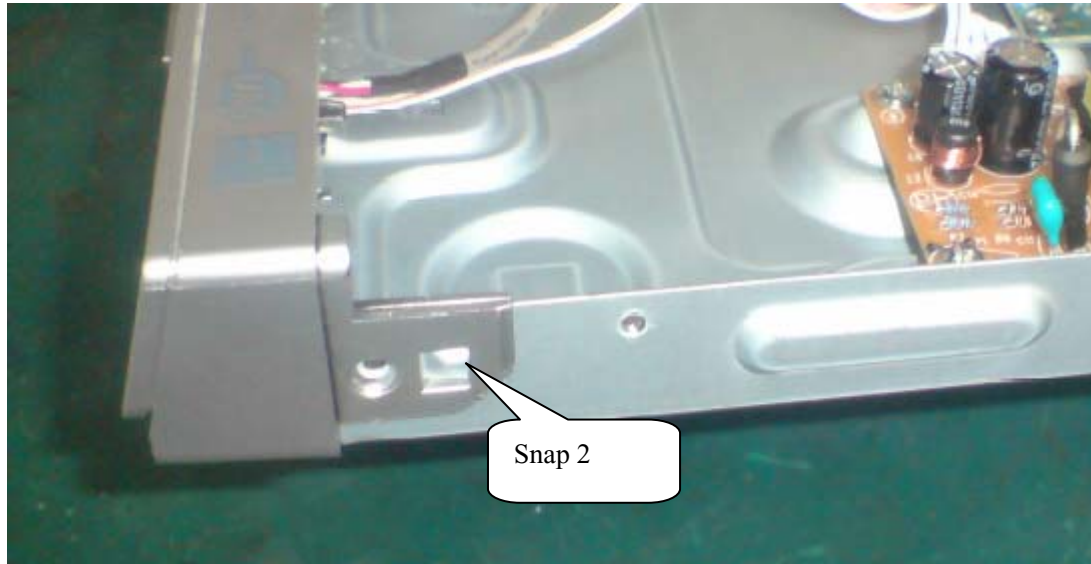

Figure 5

Step5: Dismantling Loader, disconnect the 3 connectors (XP2, XP3, XP4) aiming in the below figure, and remove 1 screw that connects the loader and the bottom cabinet. (Figure 6)

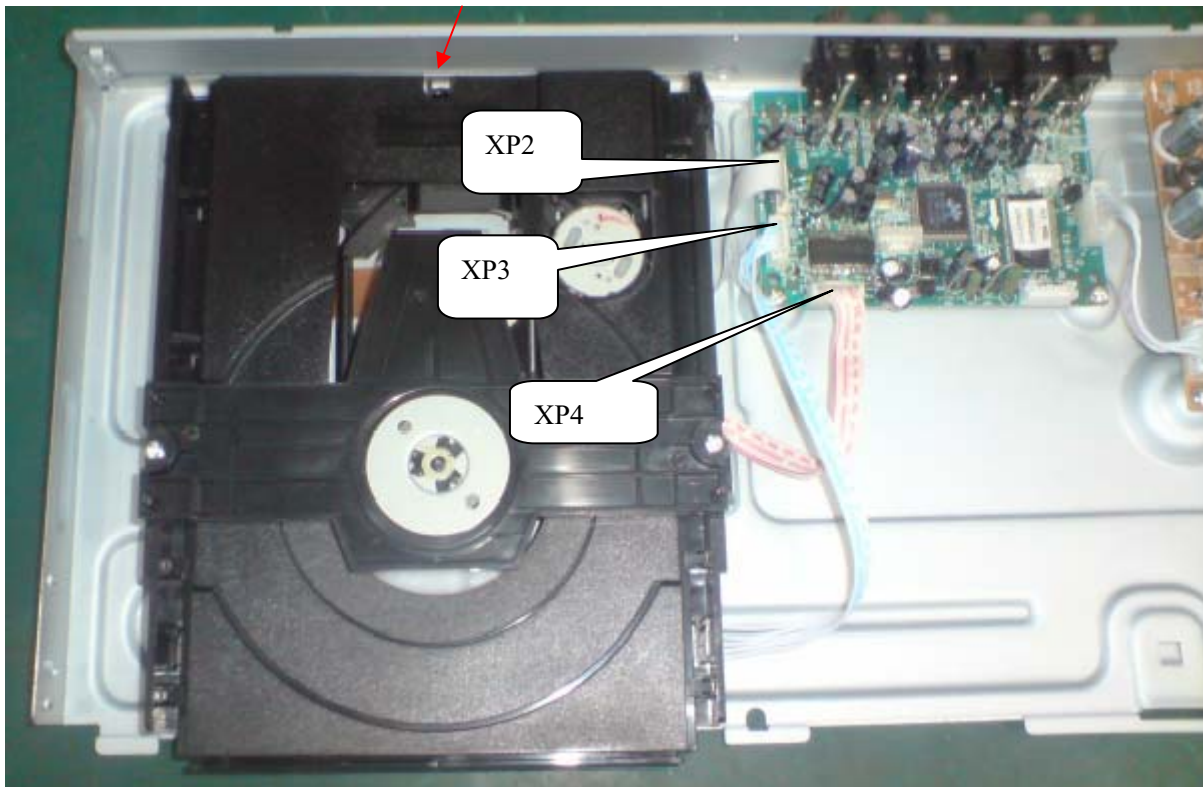

Figure 6

Mechanical and Dismantling Instructions

Dismantling Instruction

Step6: Dismantling Main Board, first disconnect the connector (XP1), and then remove 5 screws. (Figure 7)

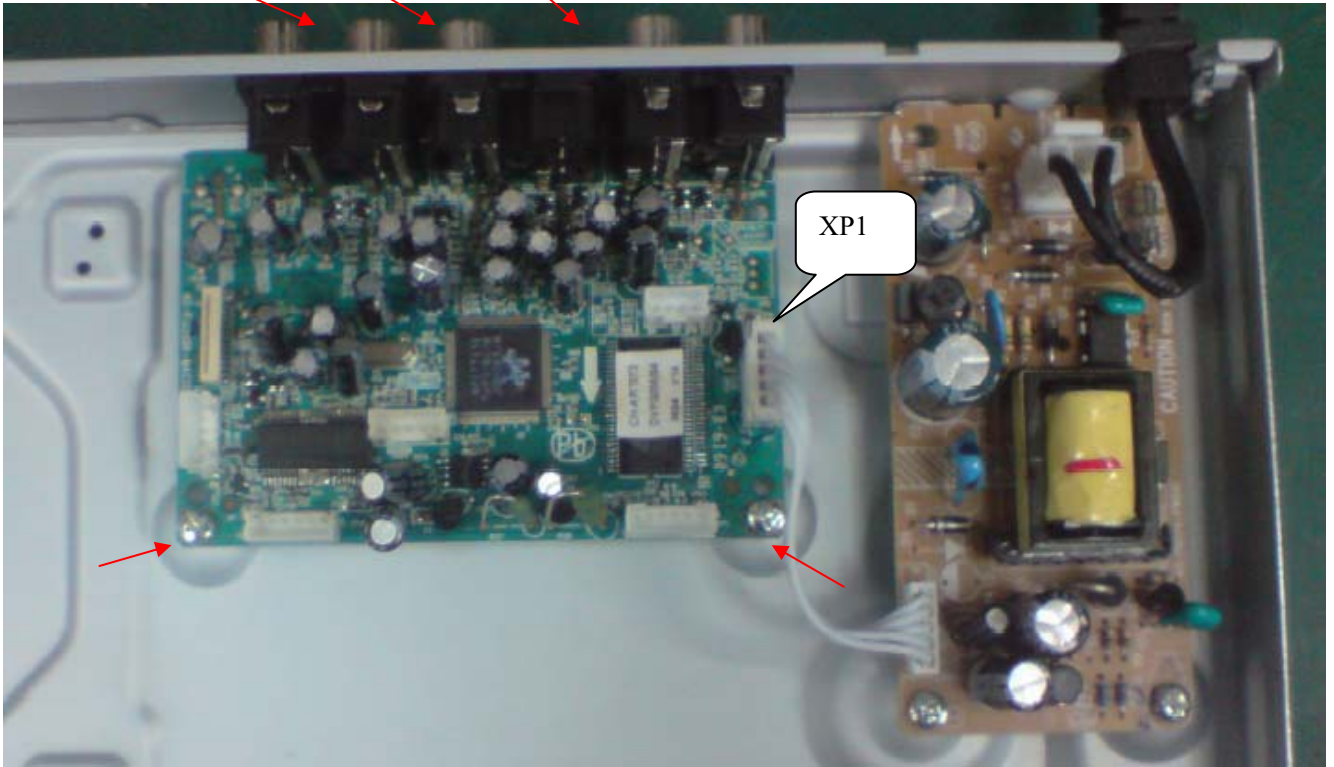

Figure 7

Step7: Remove the 2 screws on Power Board to dismantle the Power Board. (Figure 8)

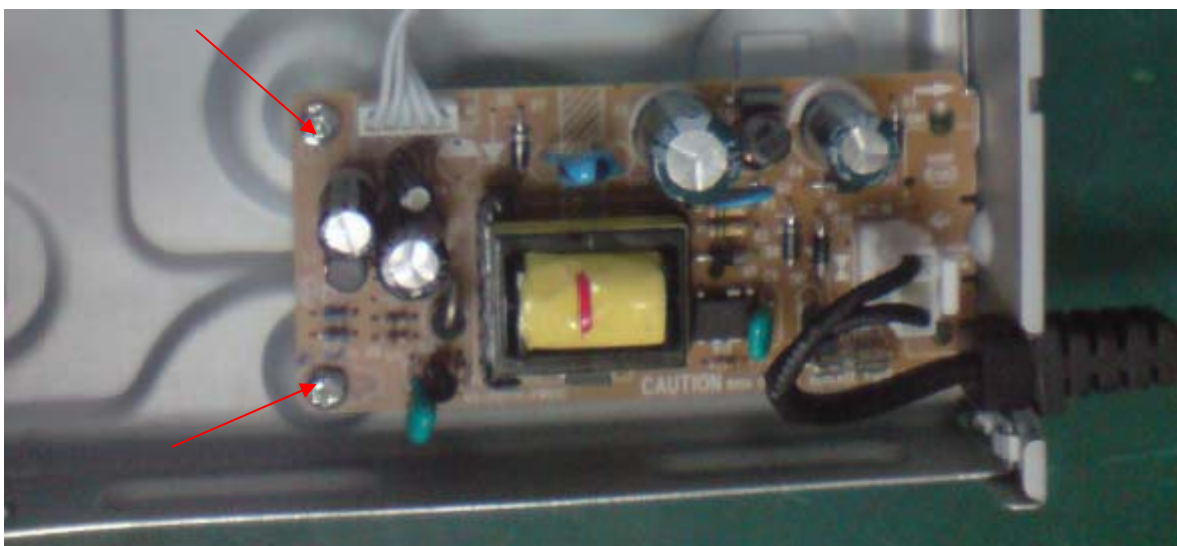

Figure 8

Software upgrade

Preparation to upgrade software

- 1) Start the CD Burning software and create a new CD project (Data Disc) with the following setting:
Label: DVP3XXX (No need the label name)
File Name: DVPXXXX_XX.BIN
Power on the set and open the tray, then press <5><5> to check the File Name.

Note: It is required capital letter for the File System name.

- 2) Burn the data onto a blank CDR

A. Procedure for software upgrade:

- 1) Power on the set and insert the prepared Upgrade CDR.
- 2) The set will starts reading disc & response with the following display TV screen:
Upgrade File DETECTED
Upgrade?
Press Play TO START.
- 3) Press <OK> button to confirm, then screen will display :
Files coping...
UPGRADING...
- 4) The upgraded tray will automatically open when files coping complete, then take out the disc.
- 5) About 1 minute later, the trace will automatically close when upgrading complete.

B. Read out the software versions to confirm upgrading

- 1) Power on the set and press <Setup> button on the remote control.
- 2) Press <1><3><7><9> button.
The software version and other information are display on the TV screen as follows:
Version XX.XX.XX.XX (Main version)
SUB-VER XX.XX.XX.XX (software version of application software)
8032 XX.XX.XX.XX
Servo XX.XX.XX.XX (software version of Servo)
RISC XX.XX.XX.XX
DSP XX.XX.XX.XX
Region Code X

Caution: The set must not be power off during upgrading, Otherwise the Main board will be damaged entirely.

How to select the right language

If the language is not right, it can be corrected by the following operation:

1. Power on the set and open the tray.
Press "6" "6" "6" "6" and "Audio" button on the remote control.

After that on the screen it shows:

PLS INPUT MODEL CODE:

2. Then input the related MODEL CODE "0".

After that on the screen it shows:

DVP × × × × × REGION × OK

(It means the language has been corrected and the player will be power off automatically.)

Spindle motor does not move

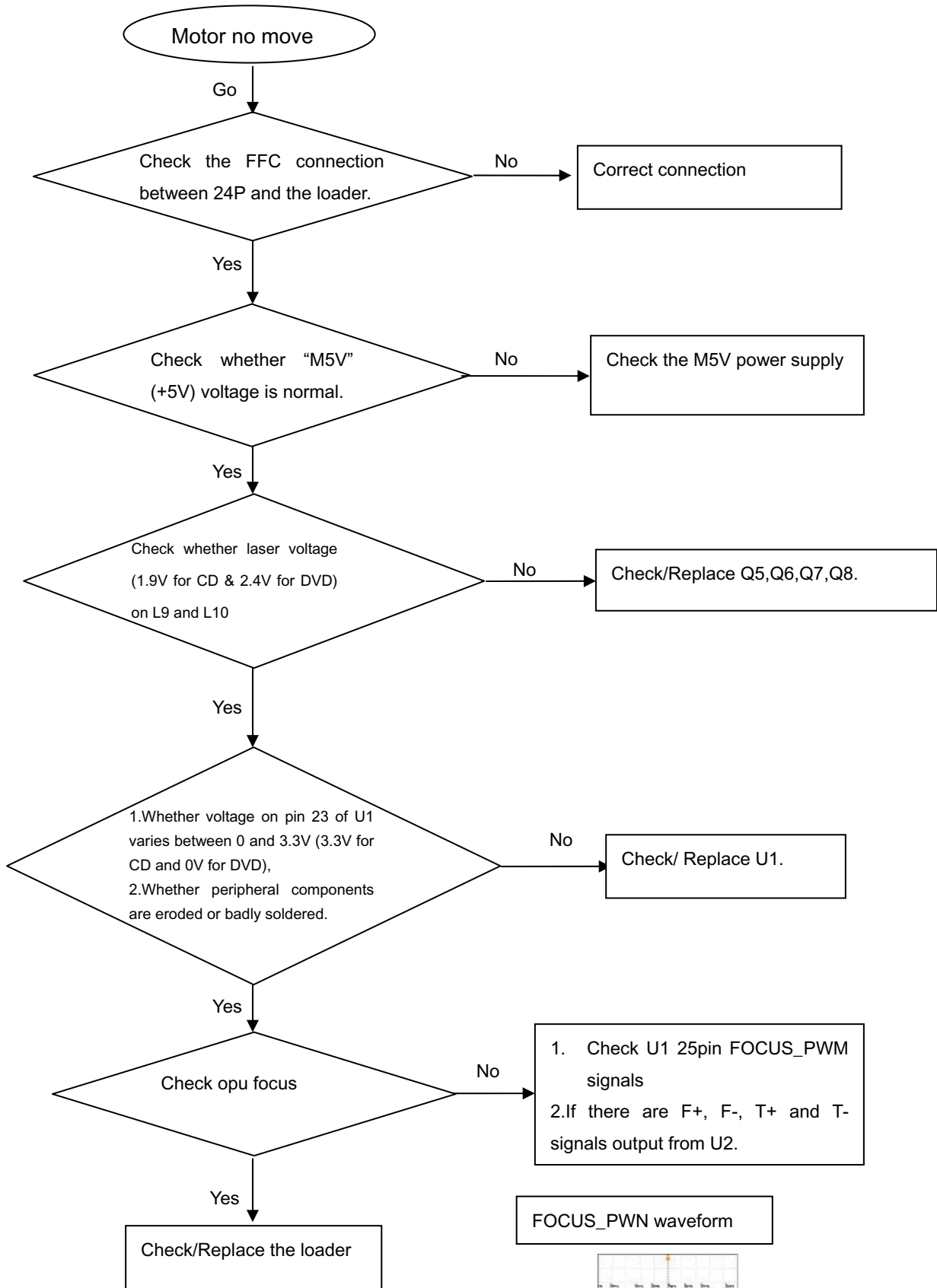

FOCUS_PWN waveform

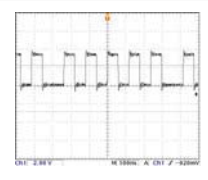

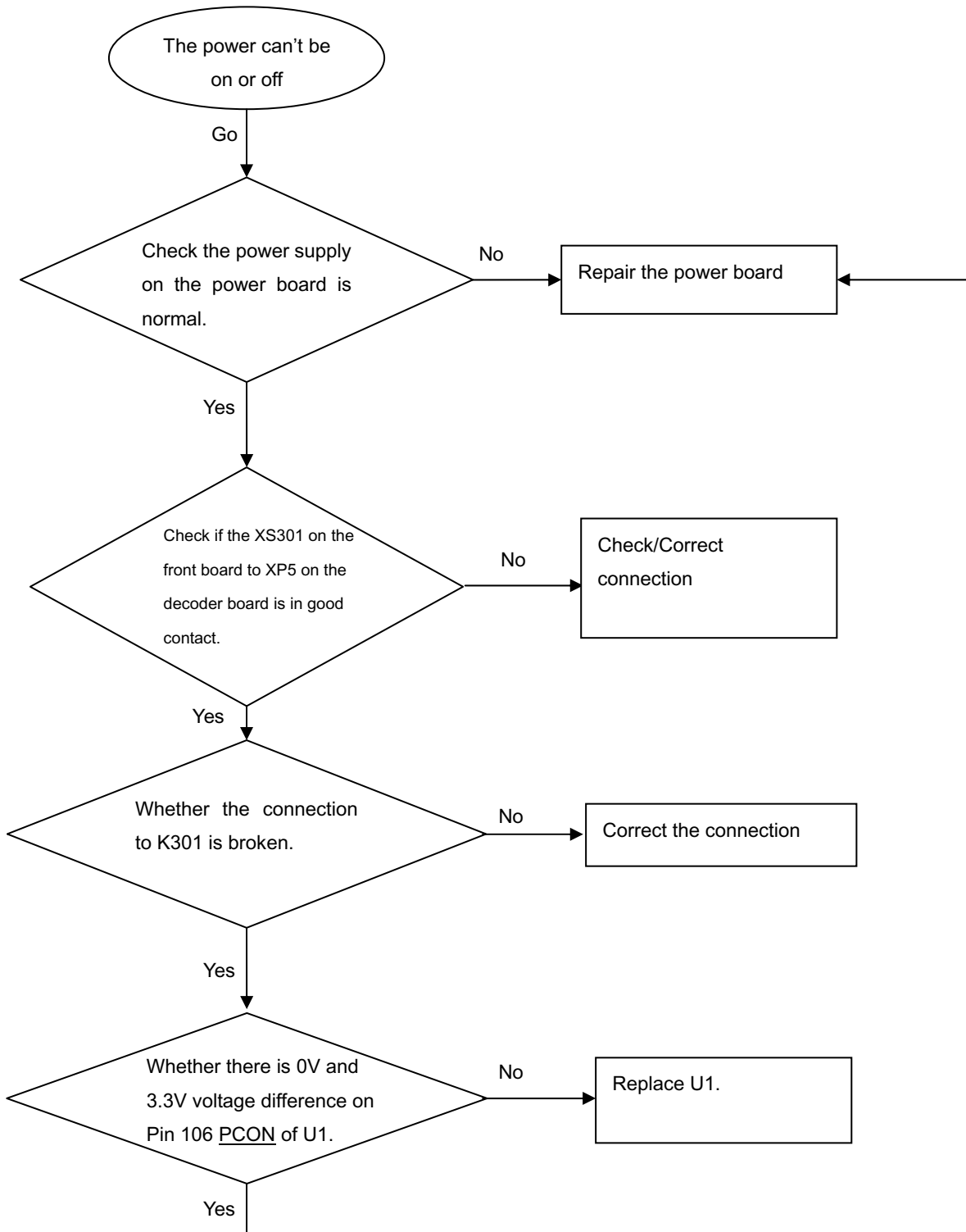
The power can not be on or off

All output voltages on the power board is 0V or deviated.

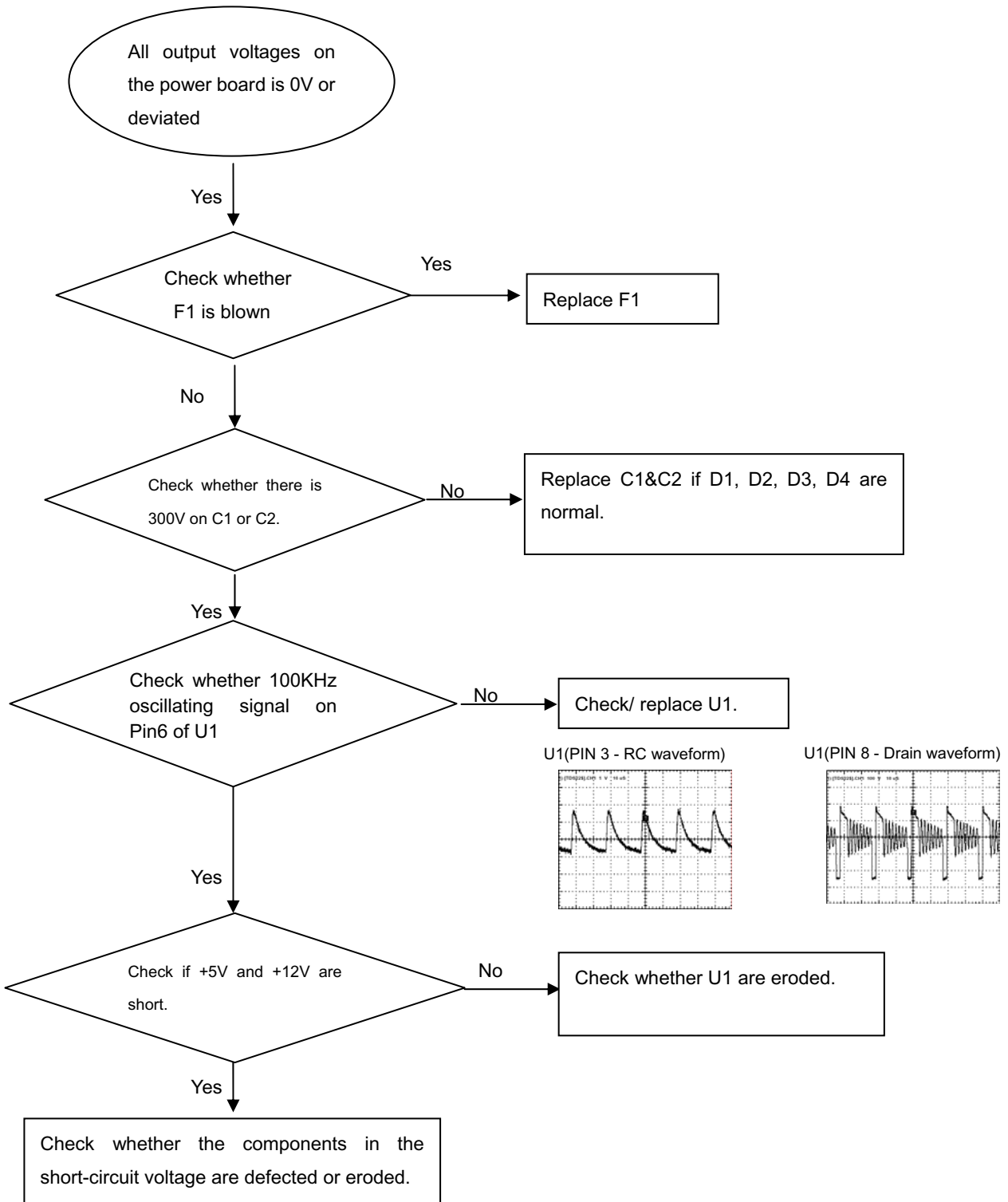

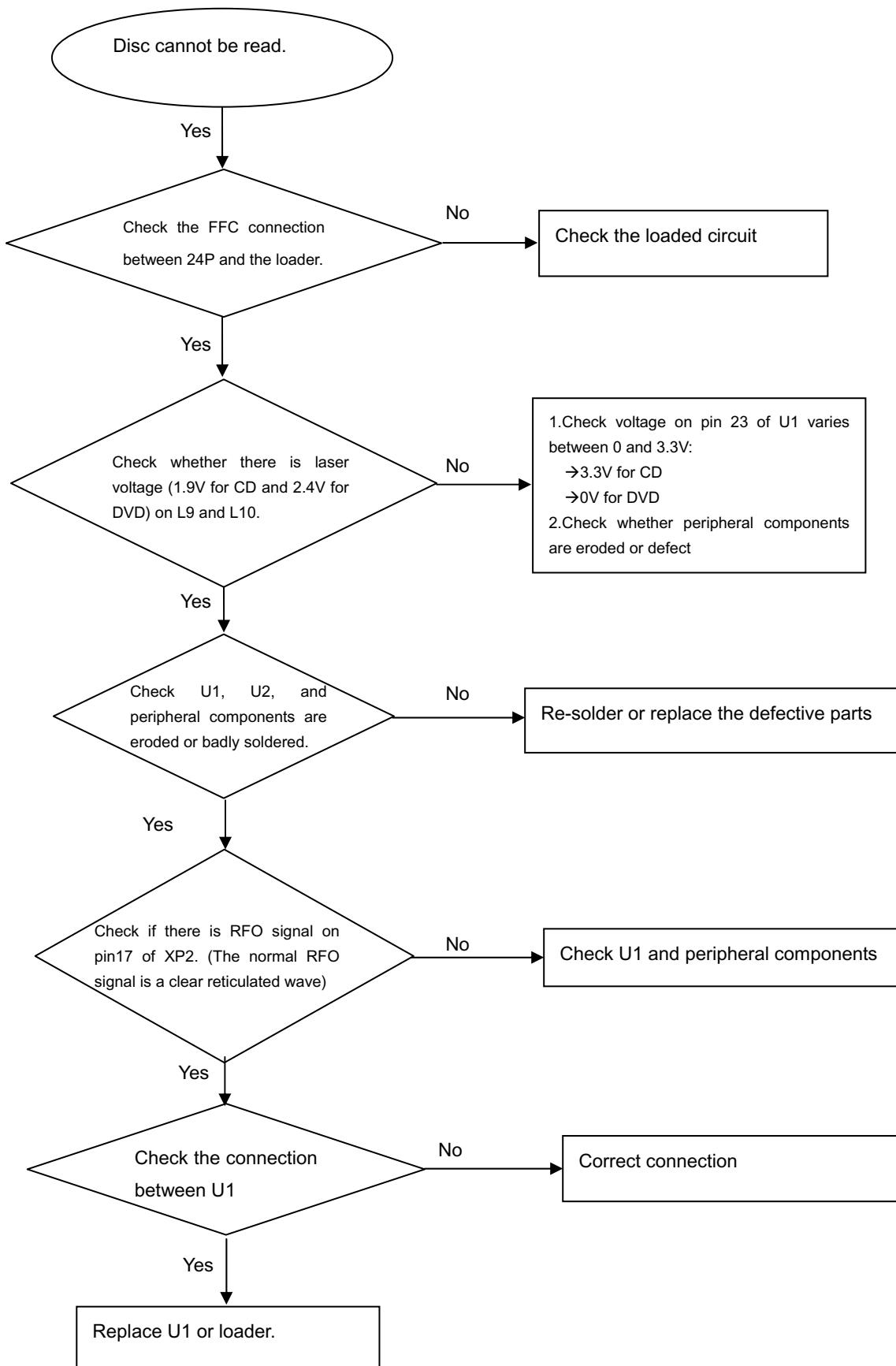
Disc cannot be read.

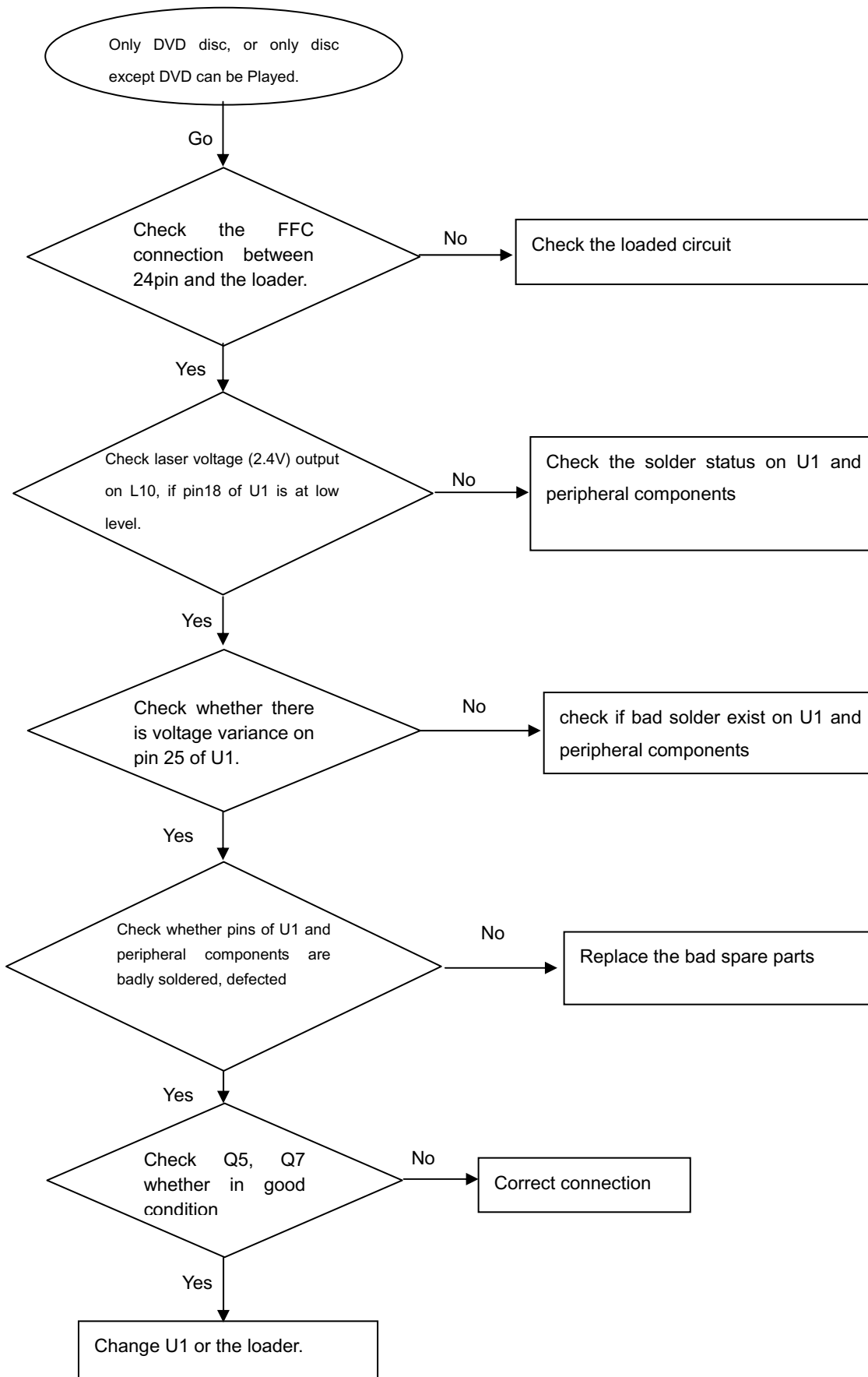
Only DVD disc or only disc except DVD can be played

No display on LED, and buttons do not work

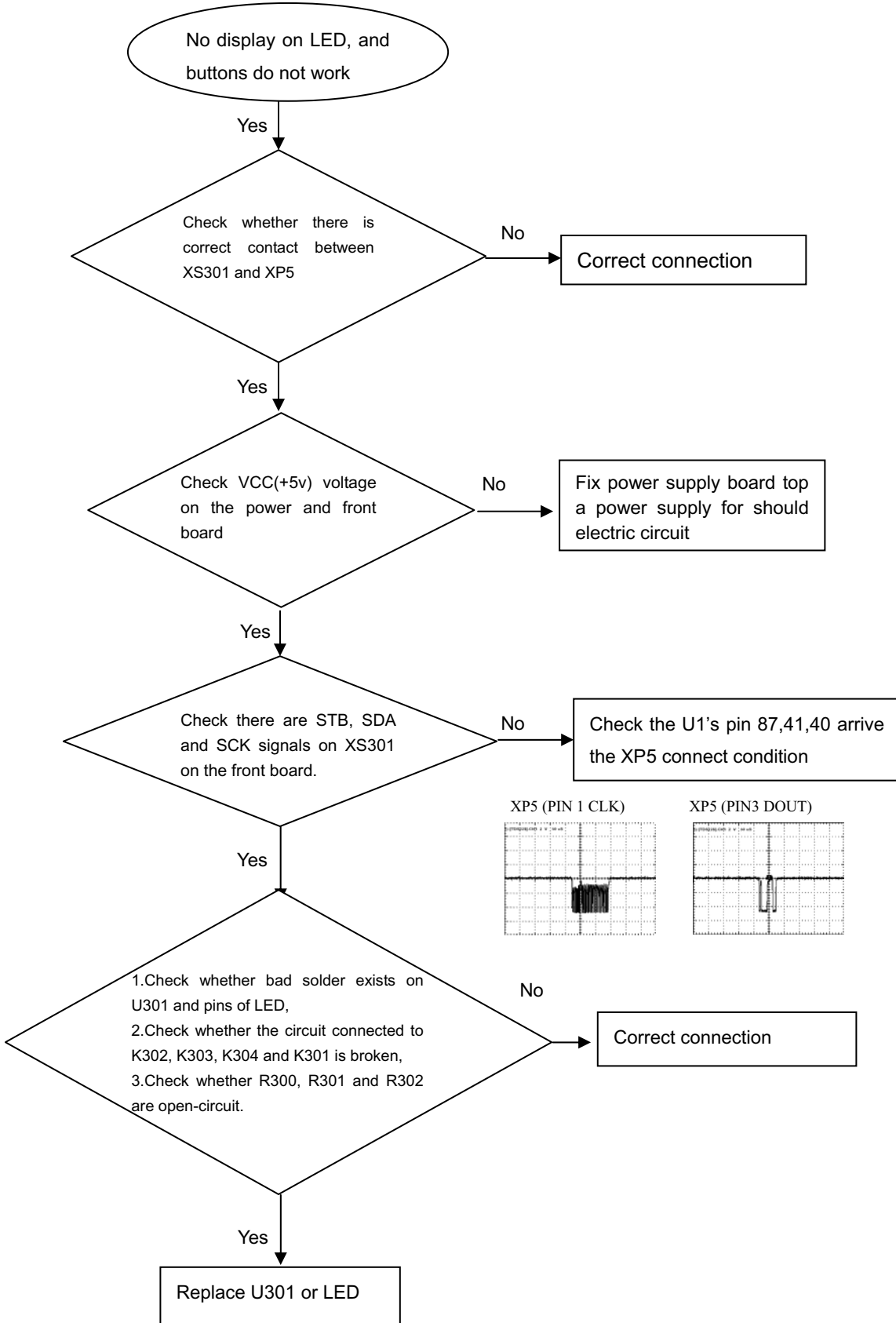

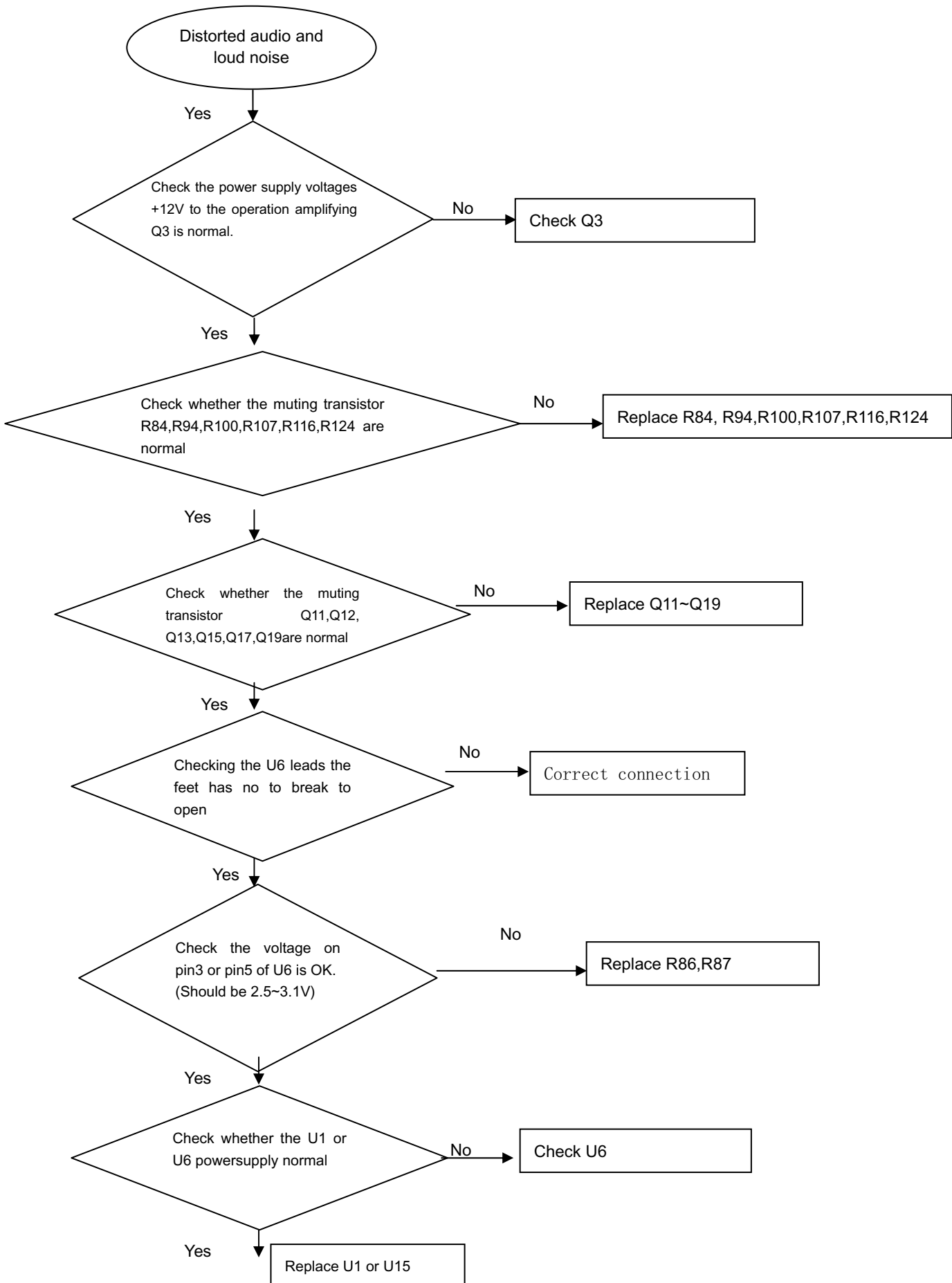
Distorted audio and loud noise

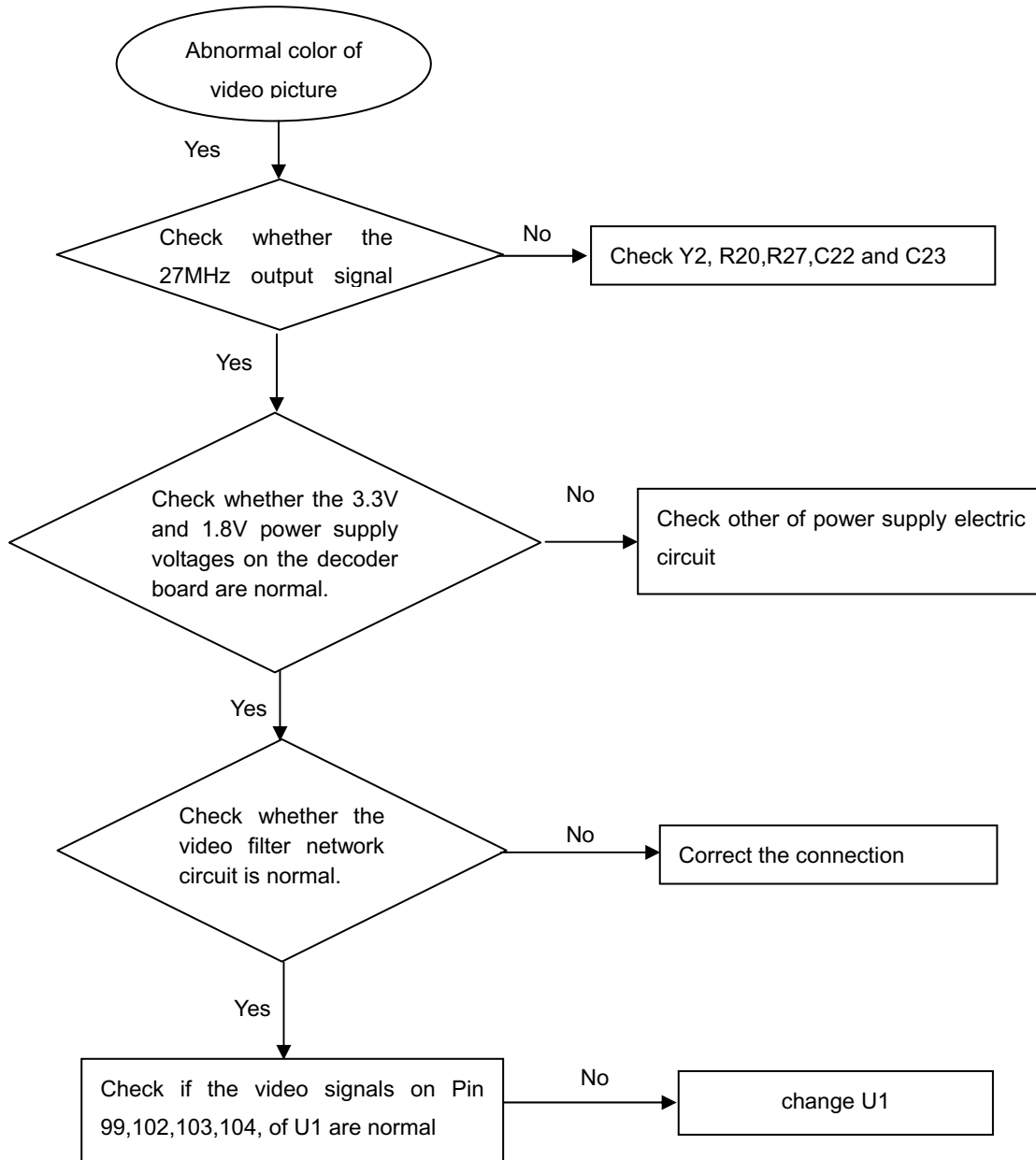
Abnormal color of video picture

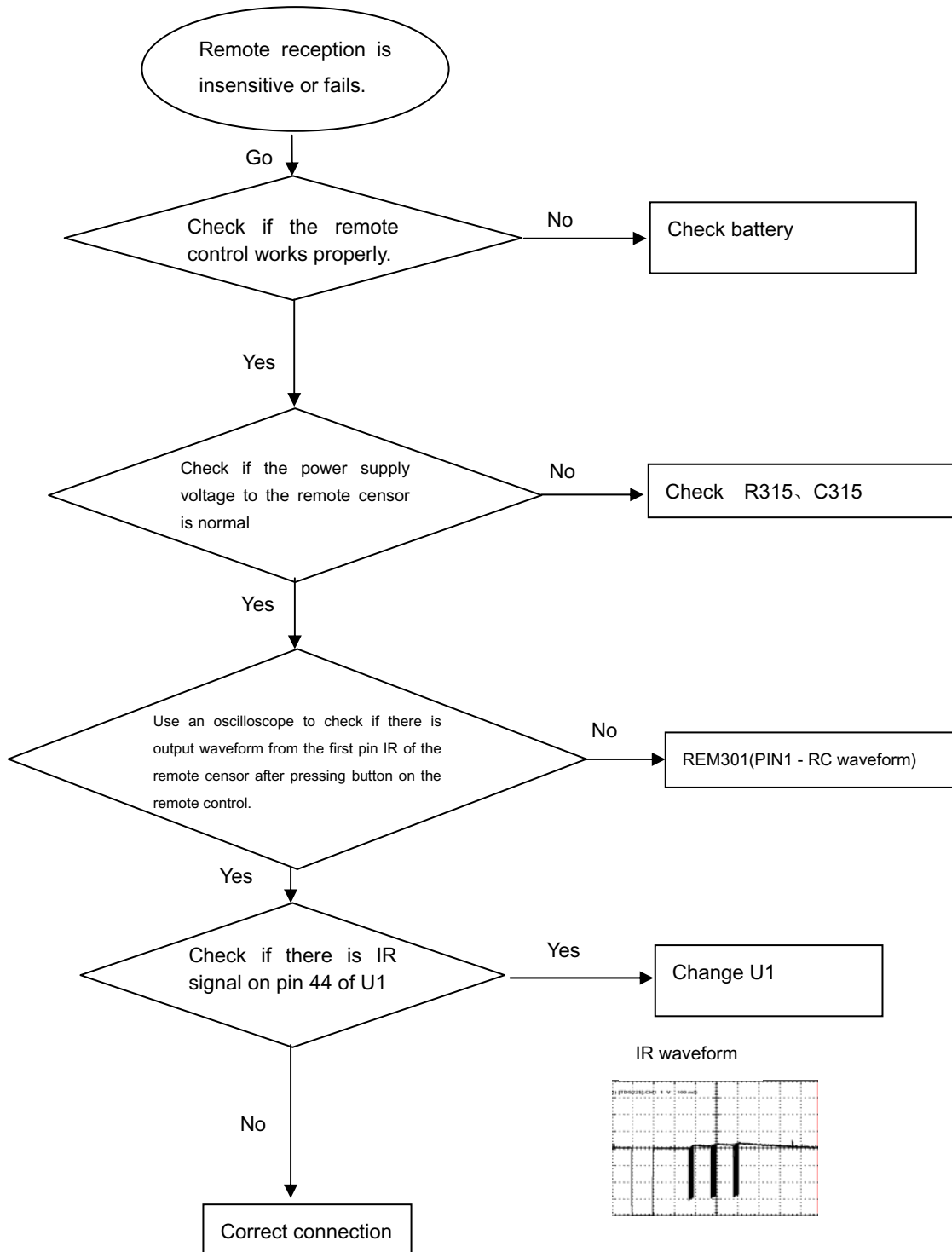
Remote reception is insensitive or fails.

No video picture, no sound.

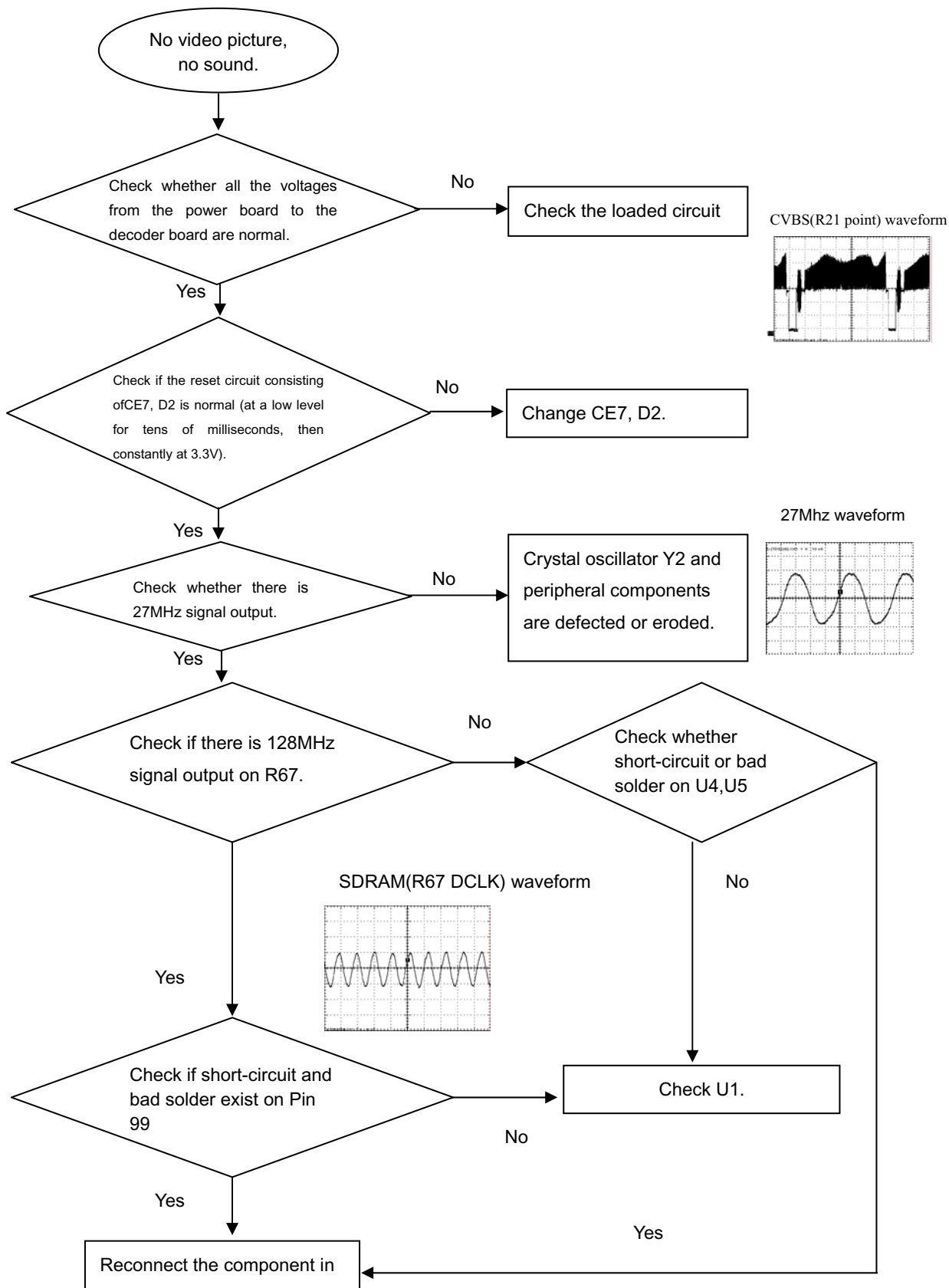

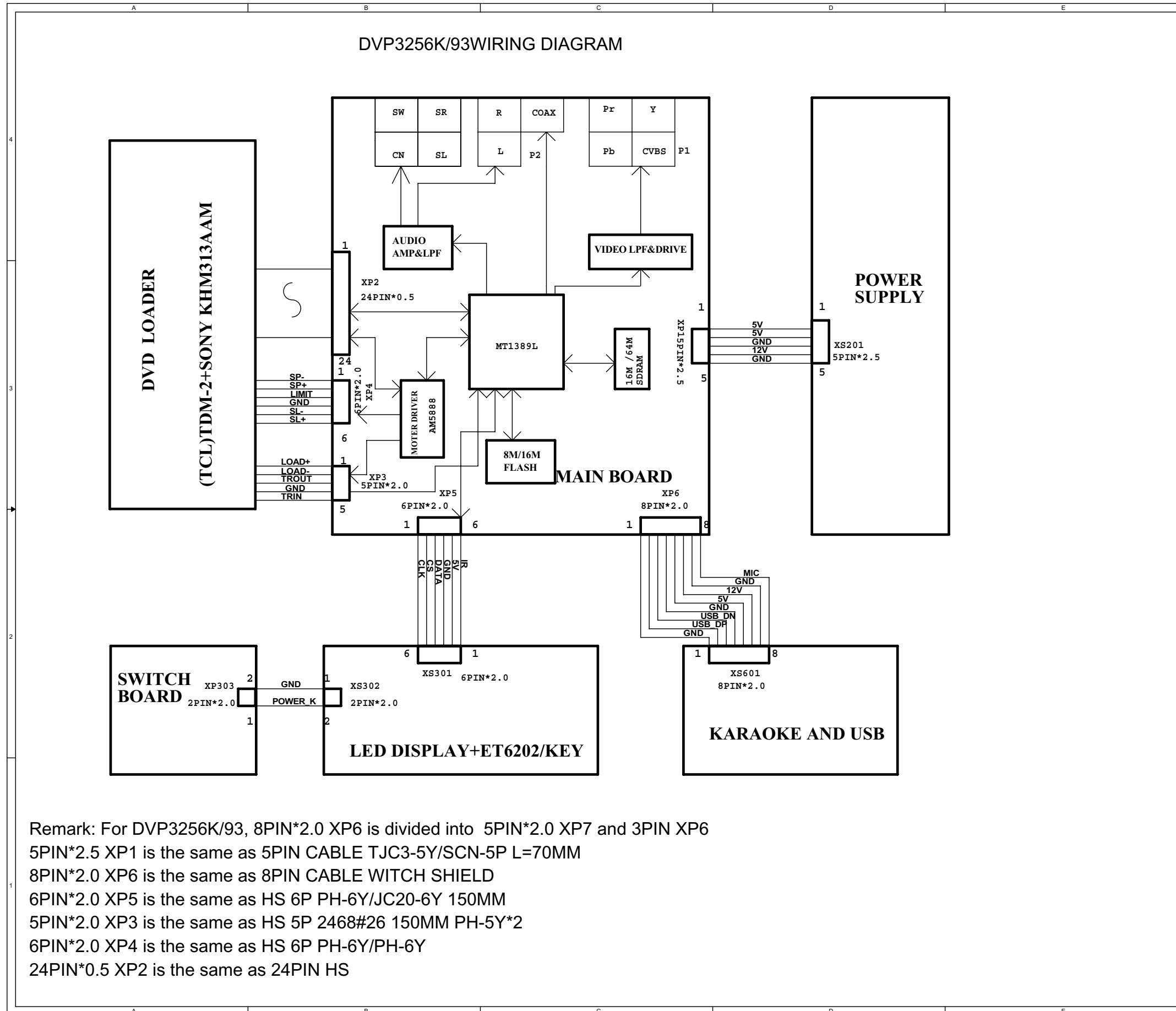

Front Board Electric Diagram

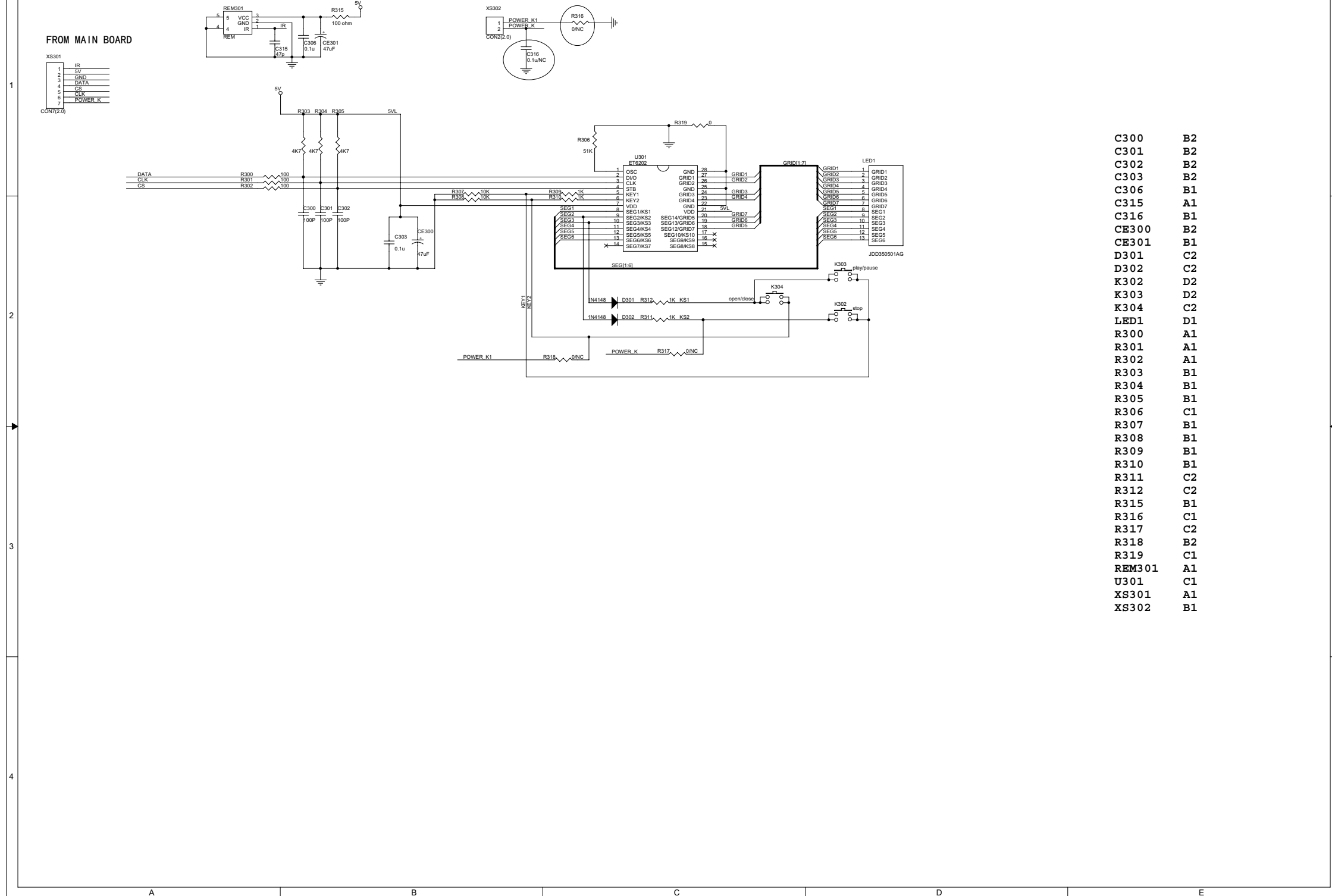

C300	B2
C301	B2
C302	B2
C303	B2
C306	B1
C315	A1
C316	B1
CE300	B2
CE301	B1
D301	C2
D302	C2
K302	D2
K303	D2
K304	C2
LED1	D1
R300	A1
R301	A1
R302	A1
R303	B1
R304	B1
R305	B1
R306	C1
R307	B1
R308	B1
R309	B1
R310	B1
R311	C2
R312	C2
R315	B1
R316	C1
R317	C2
R318	B2
R319	C1
REM301	A1
U301	C1
XS301	A1
XS302	B1

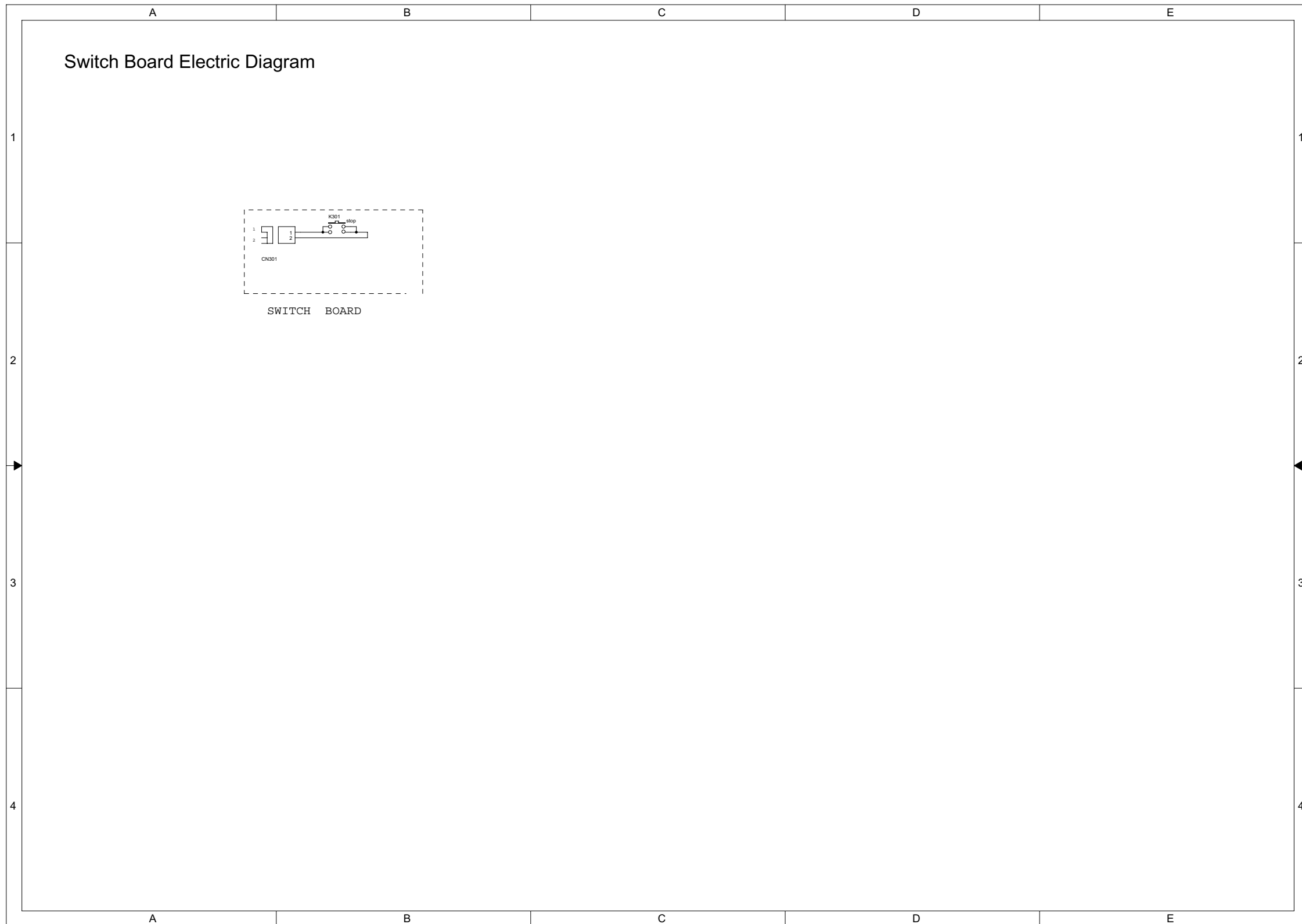

OK+USB Board Electric Diagram

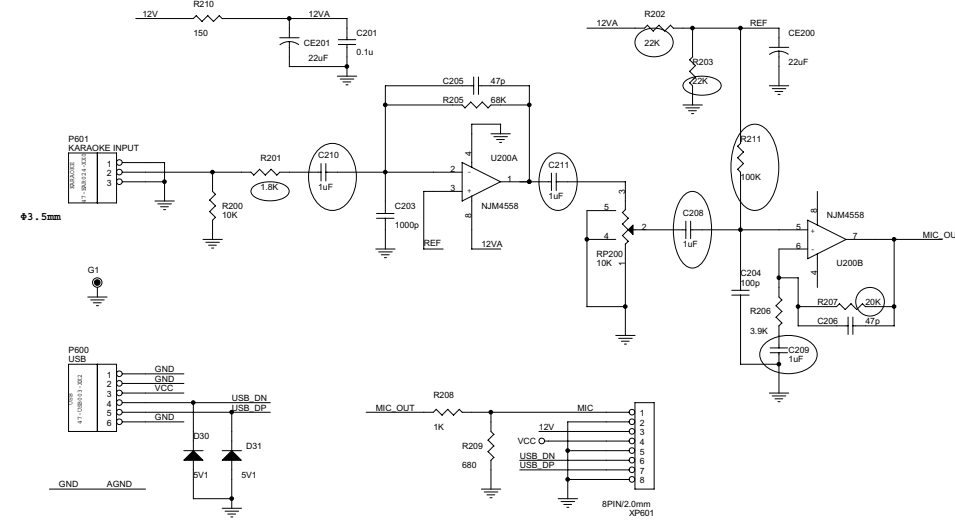

C201	B1
C203	B2
C204	C2
C205	B1
C206	C2
C208	C2
C209	C2
C210	B2
C211	B2
CE200	C1
CE201	B1
D30	B2
D31	B2
G1	A2
P600	A2
P601	A2
R200	B2
R201	B2
R202	C1
R203	C1
R205	B1
R206	C2
R207	C2
R208	B2
R209	B2
R210	B1
R211	C2
RP200	B2
U200A	B2
U200B	C2
XP601	C2

Power Board Electric Diagram

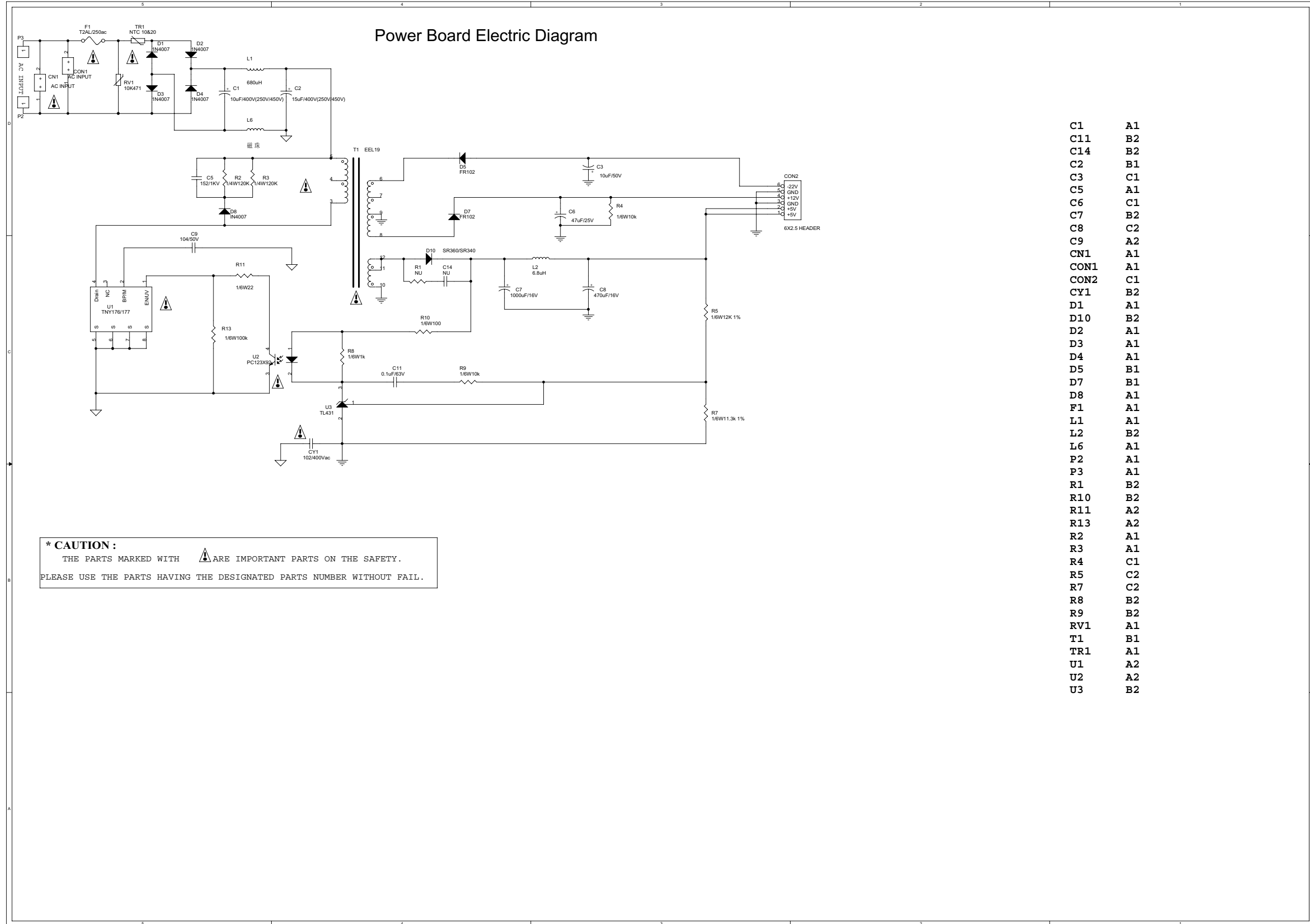

C1	A1
C11	B2
C14	B2
C2	B1
C3	C1
C5	A1
C6	C1
C7	B2
C8	C2
C9	A2
CN1	A1
CON1	A1
CON2	C1
CY1	B2
D1	A1
D10	B2
D2	A1
D3	A1
D4	A1
D5	B1
D7	B1
D8	A1
F1	A1
L1	A1
L2	B2
L6	A1
P2	A1
P3	A1
R1	B2
R10	B2
R11	A2
R13	A2
R2	A1
R3	A1
R4	C1
R5	C2
R7	C2
R8	B2
R9	B2
RV1	A1
T1	B1
TR1	A1
U1	A2
U2	A2
U3	B2

*** CAUTION :**
 THE PARTS MARKED WITH  ARE IMPORTANT PARTS ON THE SAFETY.
 PLEASE USE THE PARTS HAVING THE DESIGNATED PARTS NUMBER WITHOUT FAIL.

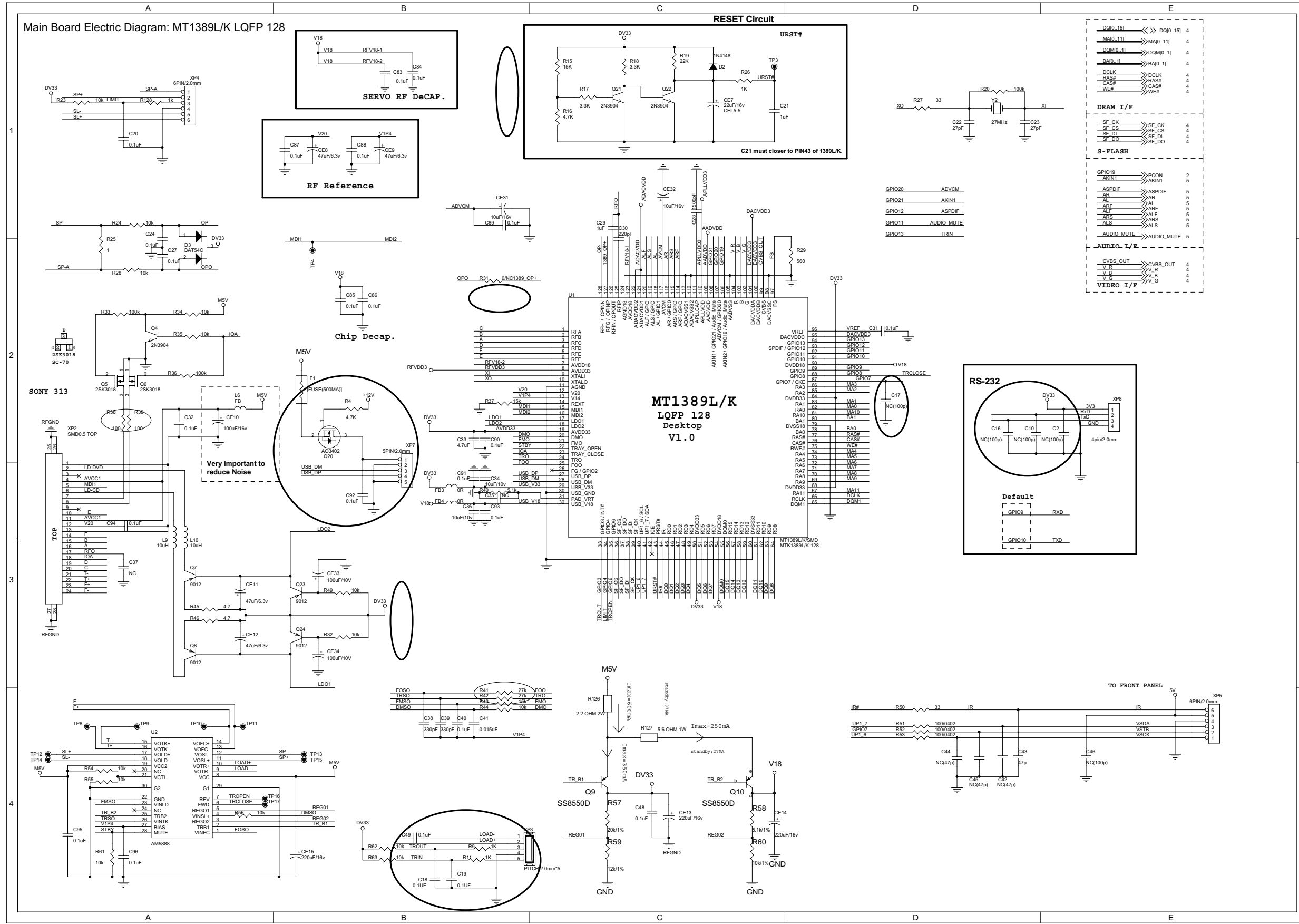

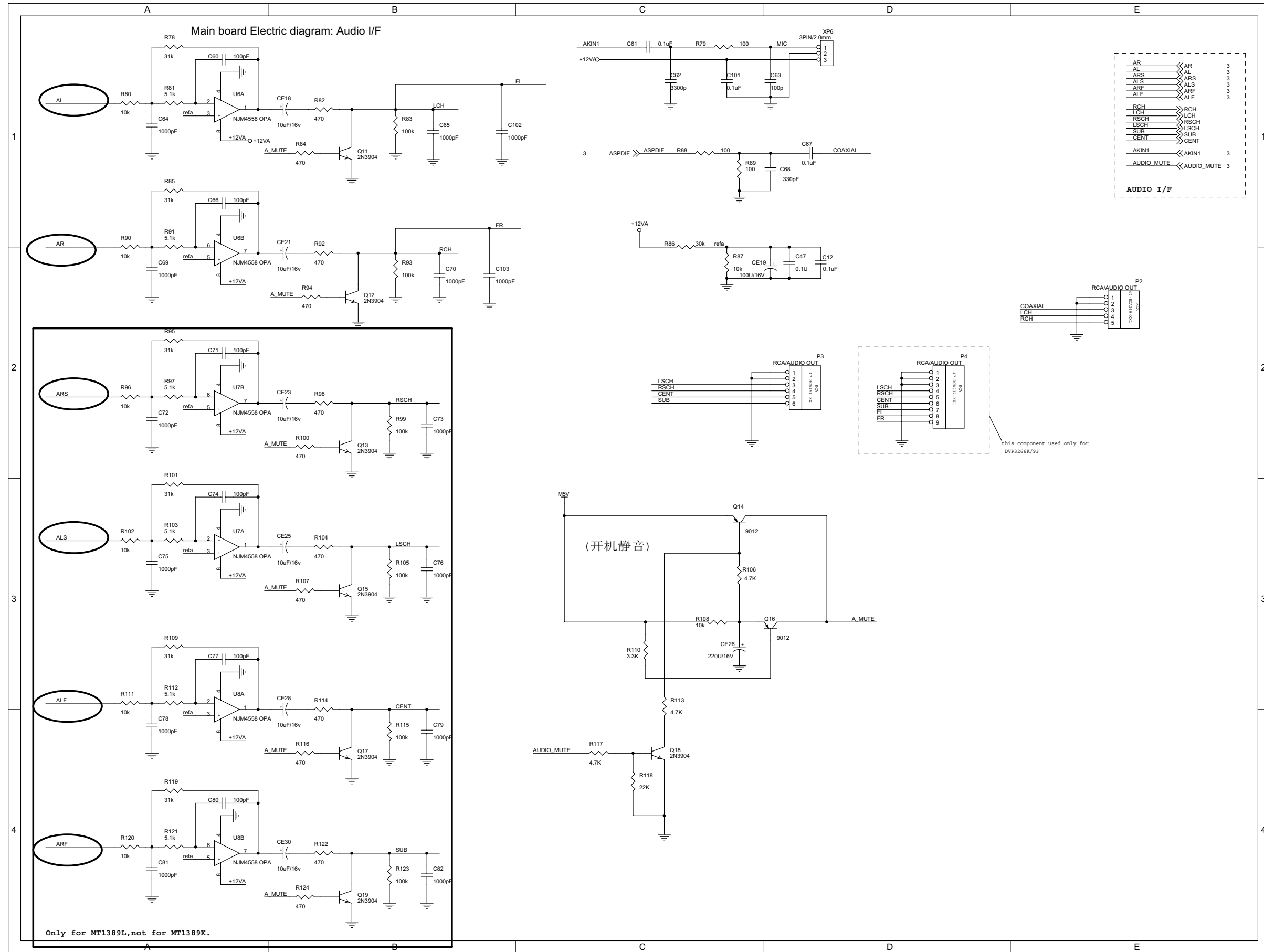

COMMON1389L/K_KHM313_AM5888_V2 Desktop Model
 MT1389L/K (LQFP128) DVD TEST Board w/ Sony KHM Series PUHs

MT1389L/K Features Support List (MIC/USB Only for MT1389L)

Main board electric diagram: POWER

Item	Features
1	5.1CH (only 2CH for 89K) + USB + VFD + AMUTE
2	
3	
4	

MT1389L/K General GPIO List

Name	PIN	Features
GPIO3	33	TROUT
GPIO4	34	LIMIT
GPIO6	35	TROPEN
GPIO7	87	VSDA
GPO_A	22	STBY
GPO_B	23	IOA
GPIO2	26	OPO
GPIO8	88	TRCLOSE
GPIO9	89	
GPIO10	91	
GPIO11	92	AUDIO MUTE
GPIO12	93	ASPDIF
GPIO13	94	TRIN
GPIO19	106	PCON
GPIO20	107	ADVCM
GPIO21	108	AKIN1
GPIOK0	27	Only for 89K
GPIOK1	28	Only for 89K
GPIOK2	31	Only for 89K

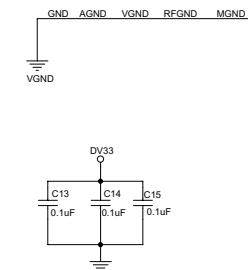
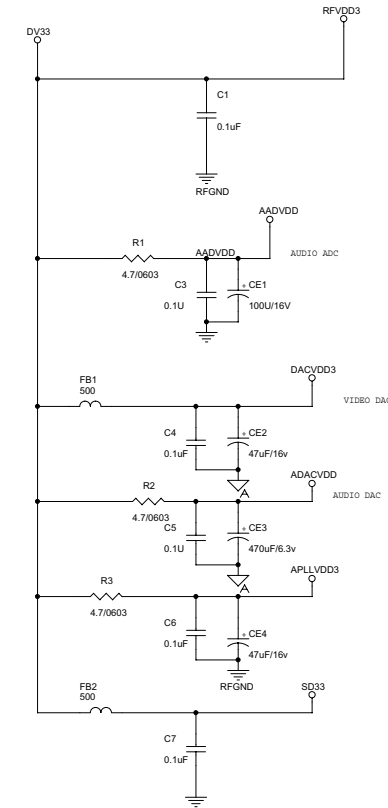
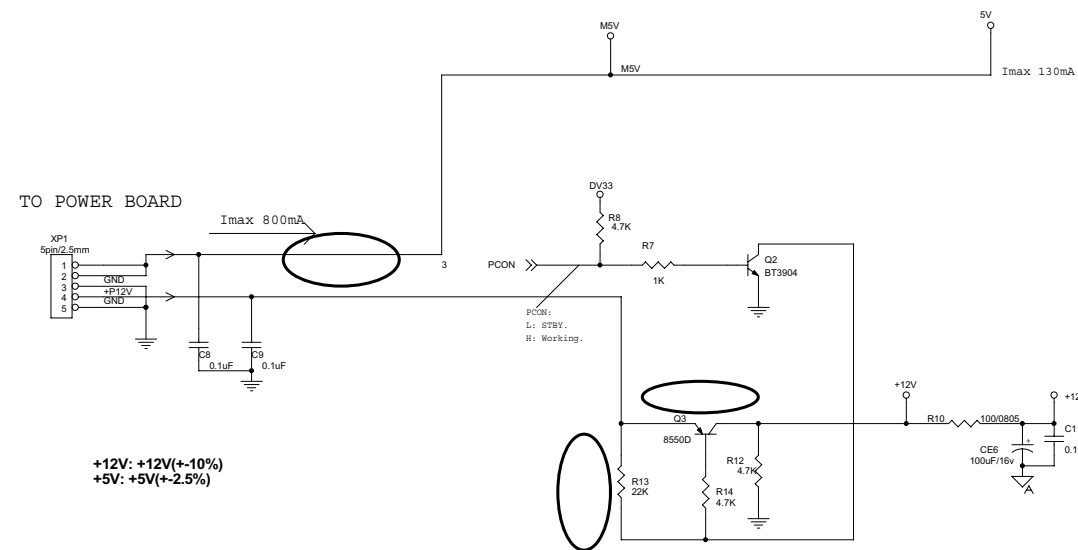

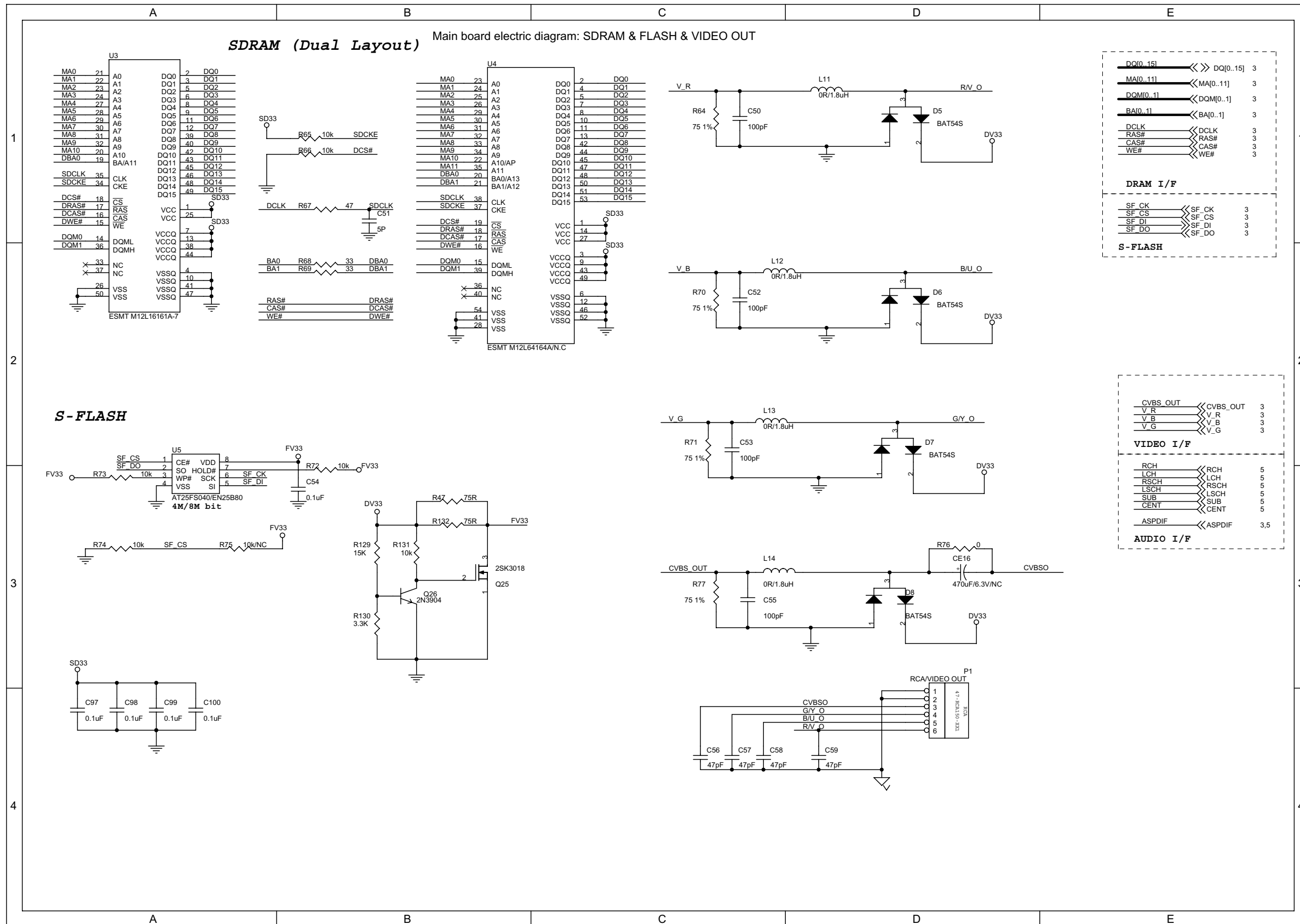

Front Board Print-layout (Bottom side)

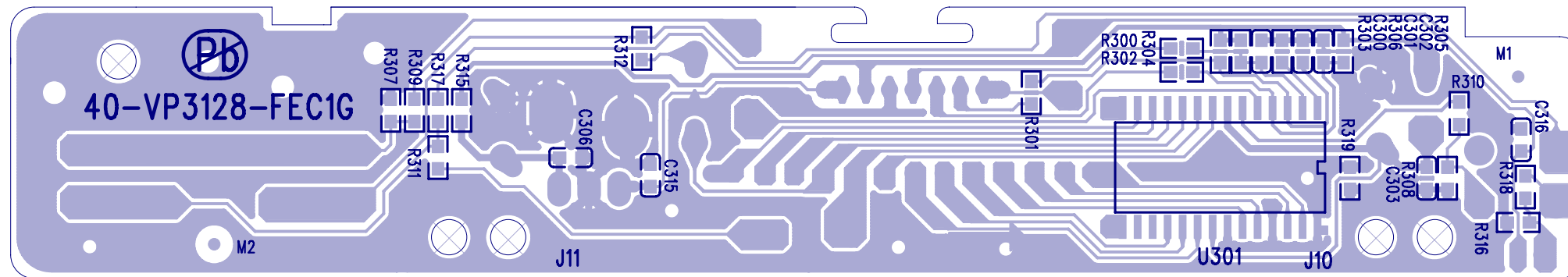

Switch Bord Print-layout (Bottom side)

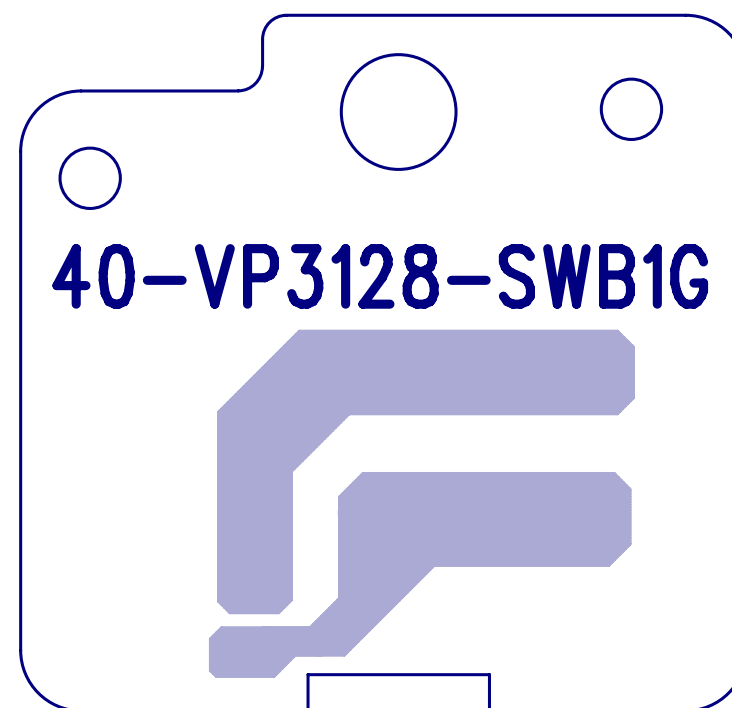

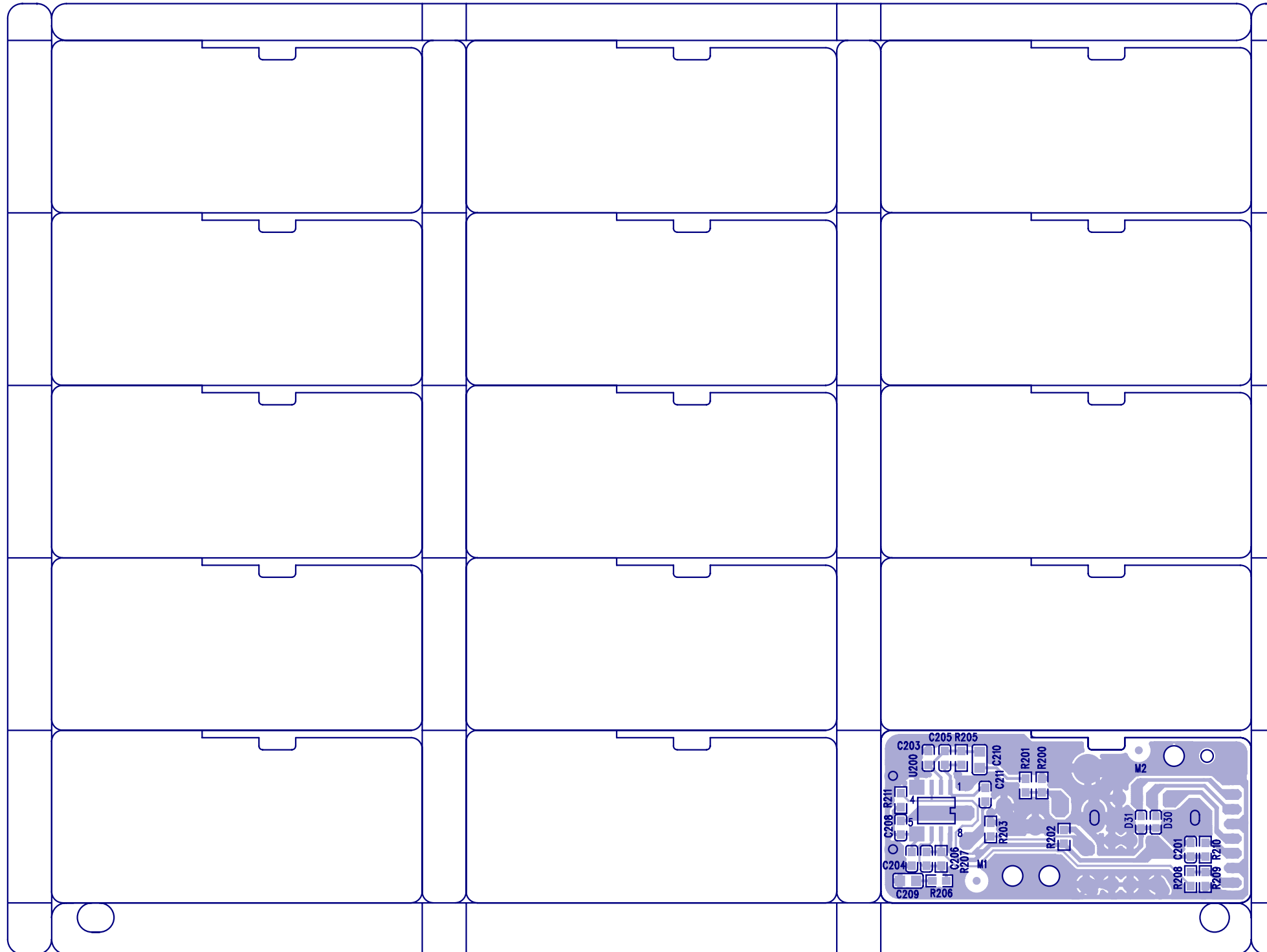

Power Board Print-layout (Bottom side)

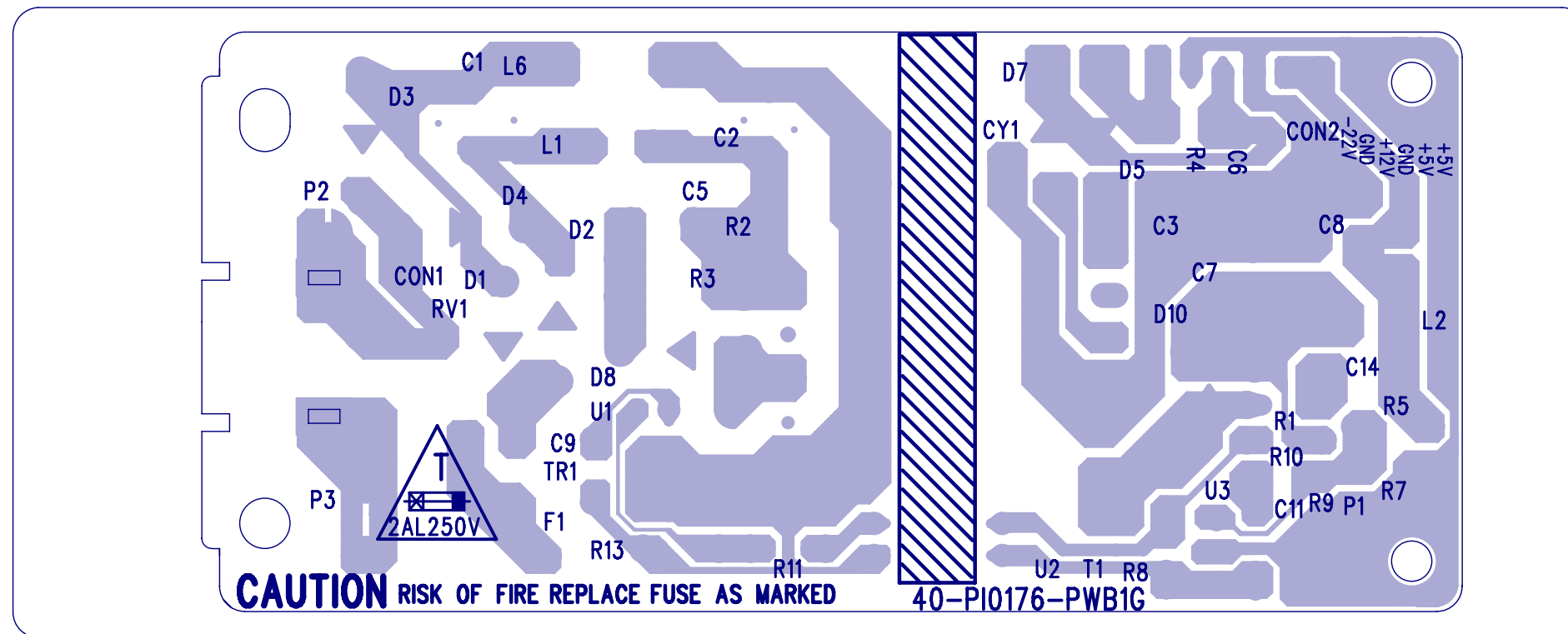

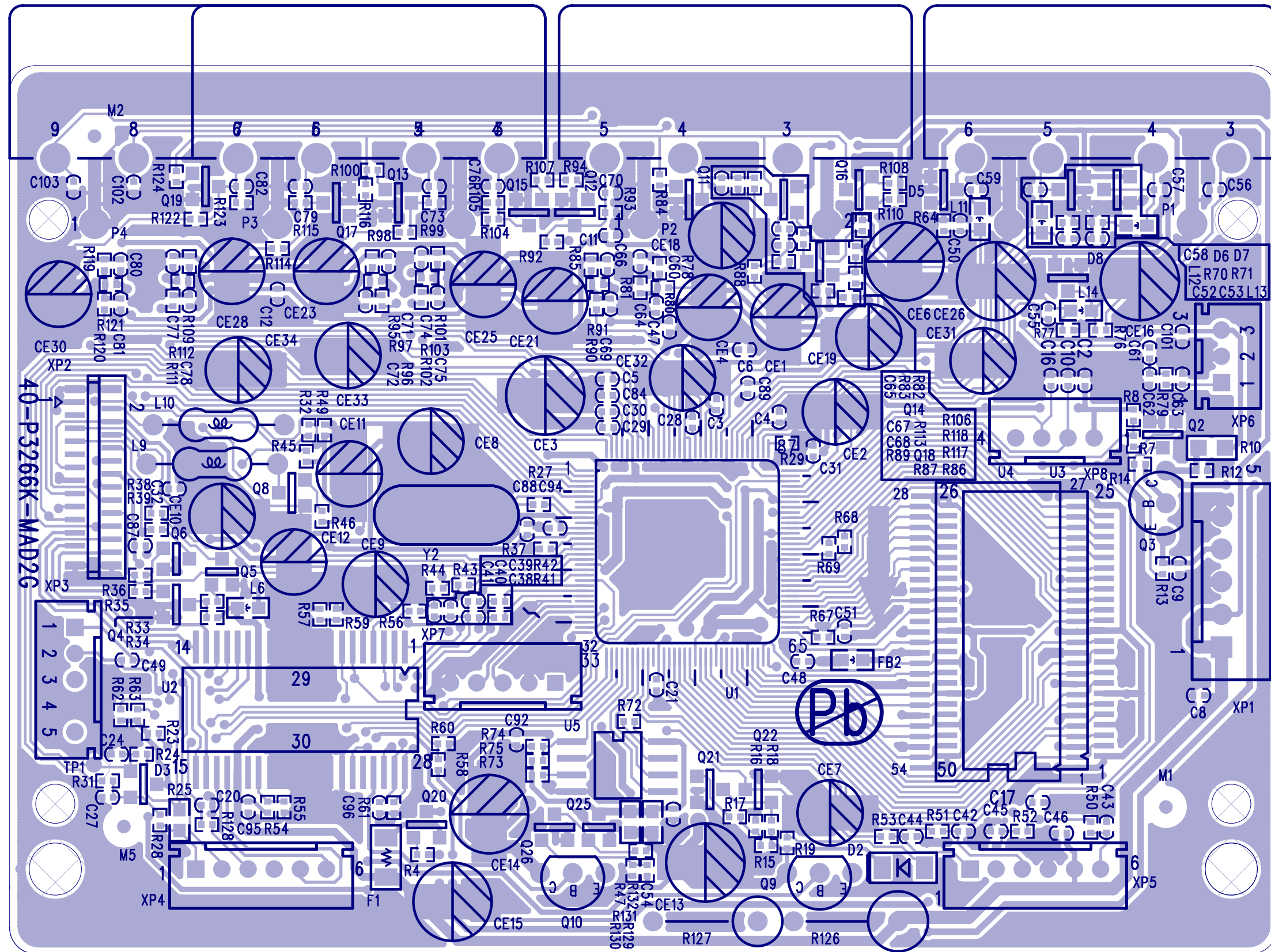

Main Board Print- layout (Bottom side)

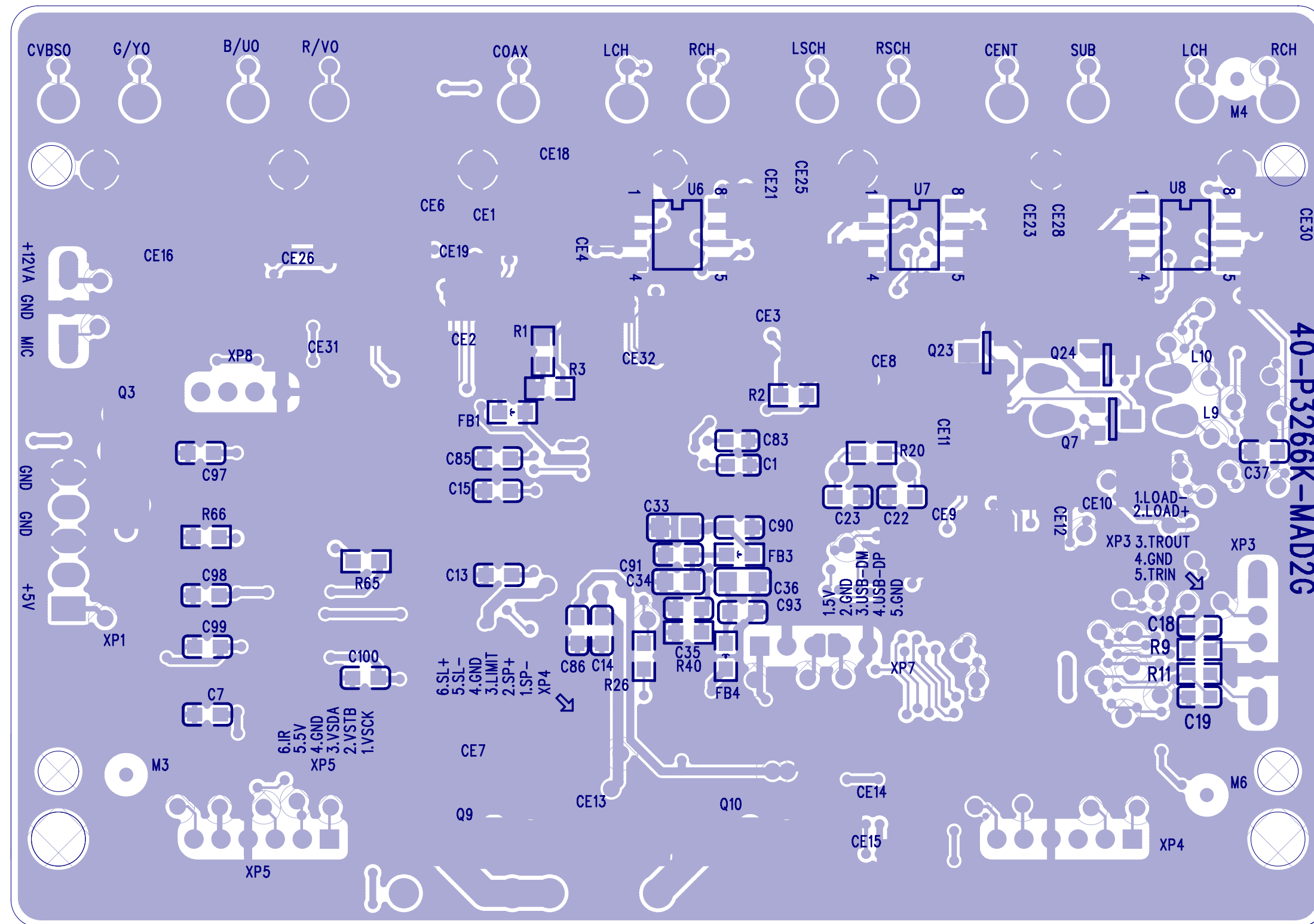

DVP3256K/93 Packing View

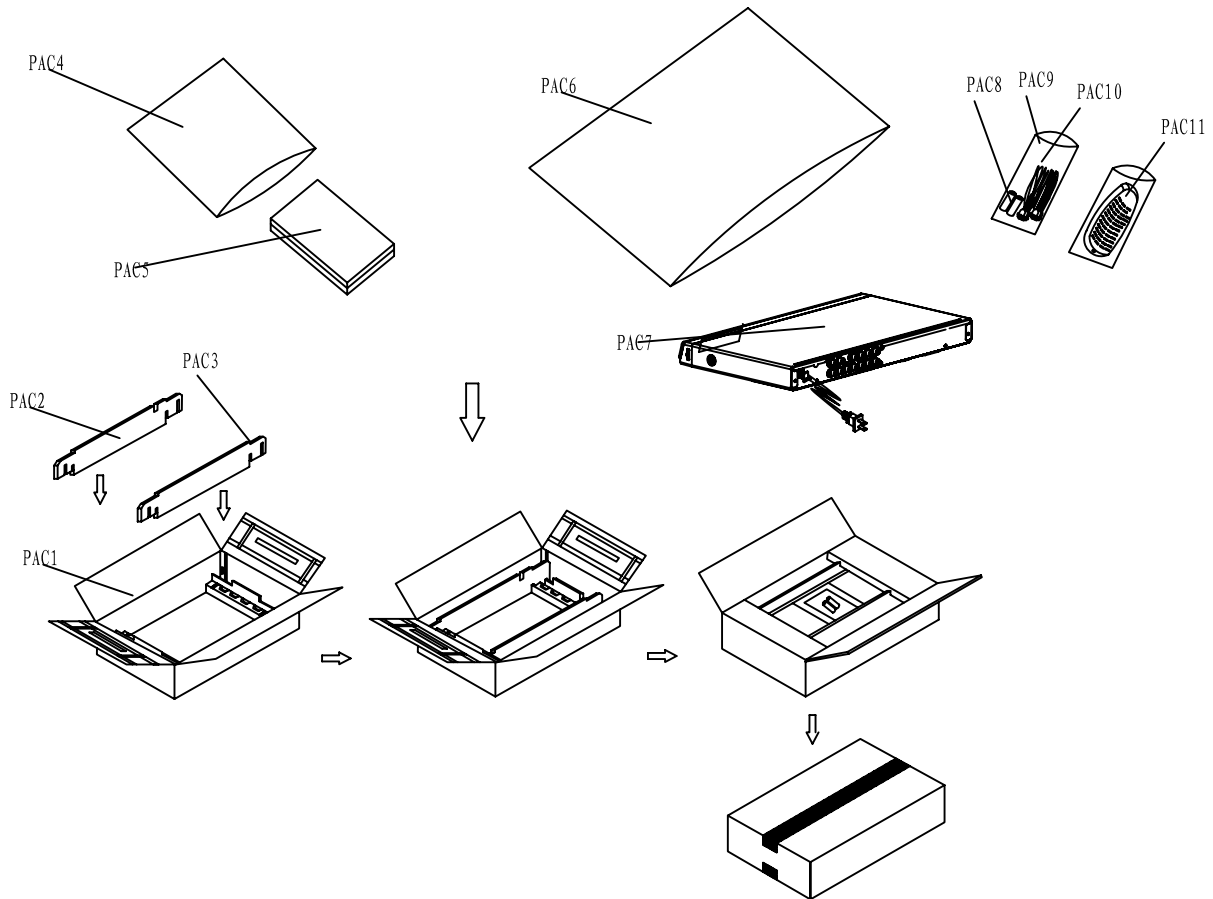

Remark:

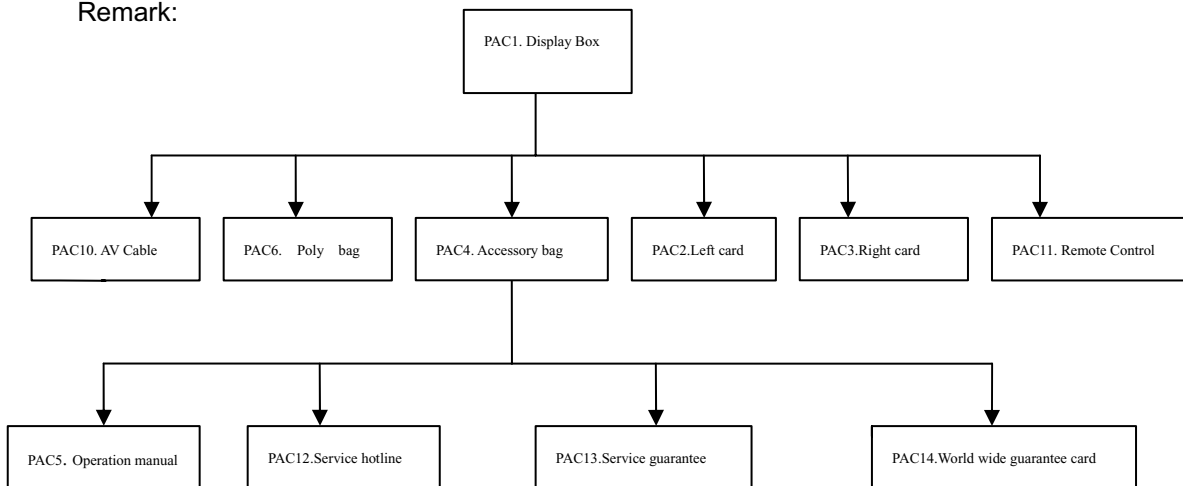

DVP3256K/93 Exploded View

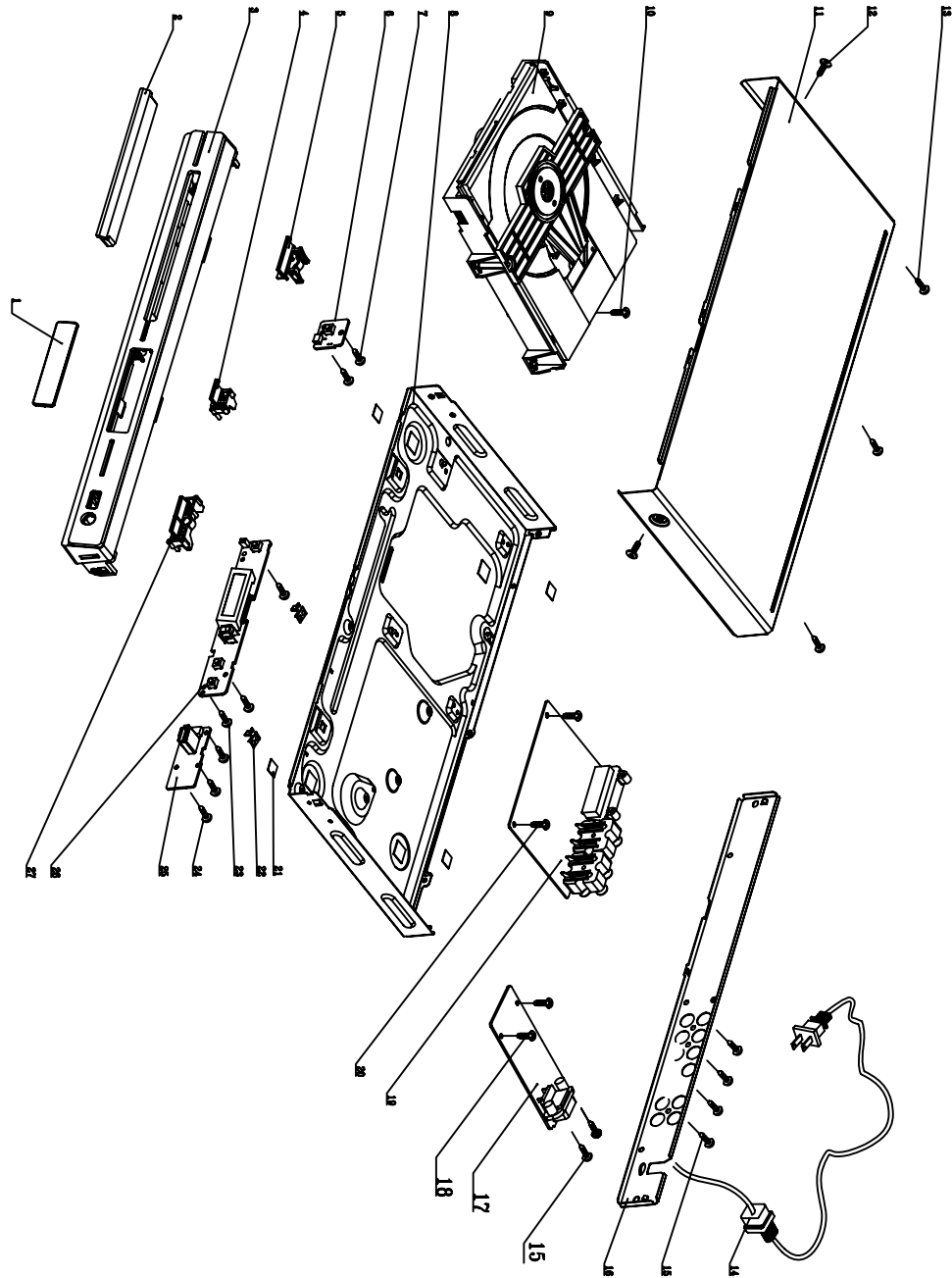

Remark: It's a general view of DVP3256K/93. Please refer to the model set for the detailed information.

Ass'y 1 includes components 1.3.4.5.27

Electrical PARTS LIST			
No	12NC No.	Part Name	Q'ty
△ 17	996510011198	ASSY- PW BD	1
D1	996510011047	DIODE IN4007	1
D10	996500027866	DIODE SR360 3A/60V	1
D2	996510011047	DIODE IN4007	1
D3	996510011047	DIODE IN4007	1
D4	996510011047	DIODE IN4007	1
D7	996500014043	DIODE FR102 (FAST RECOVERY)	1
D8	996510011047	DIODE IN4007	1
△ F1	996510001780	FUSE 2A 250V 5X20MM	1
L1	996510009942	COIL WIDTH	1
L2	996500032509	COIL SL0811-6R8K2R4	1
T1	996510010954	TRANSFORMER CONV	1
U1	996510010953	IC TNY176PN	1
U2	996500027867	PHOTOCOUPLER PS2561L1-1-V(WF)	1
U3	996500014609	IC AM431LP	1
19	996510014035	ASSY- MAIN BD	1
D2	996510009667	SMD. SWITCHING DIODE LL4148	1
D3	996510009668	BAT54C	1
D5	996510009859	SCHOTTKY DIODES BAT54S SOP-23	1
D6	996510009859	SCHOTTKY DIODES BAT54S SOP-23	1
D7	996510009859	SCHOTTKY DIODES BAT54S SOP-23	1
D8	996510009859	SCHOTTKY DIODES BAT54S SOP-23	1
L10	996500014082	COIL CHOKE 10UH +/-10%	1
L10	996500014082	COIL CHOKE 10UH +/-10%	1
L9	996500014082	COIL CHOKE 10UH +/-10%	1
L9	996500014082	COIL CHOKE 10UH +/-10%	1
Q10	996510009671	TRANSISTOR	1
Q11	996510009669	SMD.TRANSISTOR MMBT3904LT1 NPN	1
Q12	996510009669	SMD.TRANSISTOR MMBT3904LT1 NPN	1
Q13	996510009669	SMD.TRANSISTOR MMBT3904LT1 NPN	1
Q14	996510009670	TRANSISTOR SMT 3CG9012M	1
Q15	996510009669	SMD.TRANSISTOR MMBT3904LT1 NPN	1
Q16	996510009670	TRANSISTOR SMT 3CG9012M	1
Q17	996510009669	SMD.TRANSISTOR MMBT3904LT1 NPN	1
Q18	996510009669	SMD.TRANSISTOR MMBT3904LT1 NPN	1
Q19	996510009669	SMD.TRANSISTOR MMBT3904LT1 NPN	1
Q2	996510009669	SMD.TRANSISTOR MMBT3904LT1 NPN	1
Q20	996510010949	MOSFET AO3402	1
Q21	996510009669	SMD.TRANSISTOR MMBT3904LT1 NPN	1
Q22	996510009669	SMD.TRANSISTOR MMBT3904LT1 NPN	1
Q23	996510009670	TRANSISTOR SMT 3CG9012M	1
Q24	996510009670	TRANSISTOR SMT 3CG9012M	1
Q3	996510009671	TRANSISTOR	1
Q4	996510009669	SMD.TRANSISTOR MMBT3904LT1 NPN	1
Q5	996510009769	N Channel MOSFET 2SK3108	1
Q6	996510009769	N Channel MOSFET 2SK3108	1
Q7	996510009670	TRANSISTOR SMT 3CG9012M	1
Q8	996510009670	TRANSISTOR SMT 3CG9012M	1
Q9	996510009671	TRANSISTOR	1
U1	996510010950	IC MT1389DE/L	1
U2	996510009674	IC AM5888IC	1
U4	996510009770	64M SDRAM EM638165TS-7G TSOP54	1
U5	996510011197	16M SER FLASH S08 A25L16PTM-F	1
U6	996510010924	F45580 IC	1
U7	996510010924	F45580 IC	1
U8	996510010924	F45580 IC	1
Y2	996510009675	27MCL20PF	1
25	996510010958	KU BD	1
U200	996500032494	IC AS4558M	1
26	996510010956	ASSY- FB BD	1
LED1	996510010957	LED	1
REM3	996510010903	IR RECEIVER MODULE 14MM 5V	1
U301	996510009665	IC ET6202 SOP-2	1
6	996510010955	ASSY- SW BD	1
9	996510002887	ASSY-LOADER	1
OPU	996510006029	SONY AAM OPU	1

MECHANICAL & ACCESSORIES PARTS LIST			
No	12NC No.	Part Name	Q'ty
11	996510001682	TOP COVER	1
△ 14	996510011203	POWER CORD	1
16	996510011204	BACK PANEL	1
2	996510011201	FRONT DOOR	1
21	996510006463	PAD	1
8	996510011066	BOTTOM CABINET	1
ASSY1	996510011202	ASSY - FRONT CABINET	1
AVCable	996510001106	VIDEO CABLE 1500mm	1
PAC1	996510011200	DISPLAY BOX	1
PAC11	996510015381	REMOTE CONTROL	1
PAC12	996500042132	SERVICE HOT LINE	1
PAC13	996500033761	SERVICE GUARANTEE	1
PAC14	996510008988	WORLD-WIDE GUARANTEE	1
PAC2	996510001202	LEFT BUFFER	1
PAC3	996510001203	RIGHT BUFFER	1
PAC4	996510007475	ACCESSORY BAG	1
PAC5	996510015589	OPERATION MANUAL	1
PAC6	996510007433	POLY BAG	1
XP1	996510011060	5PINBLE TJC3-5Y/SCN-5P L=70MM	1
XP2	996510001168	24PIN HS	1
XP3	996510005284	CABLE HS 5P 2468#26 150MM PH	1
XP4	996510001222	HS 6P PH-6Y/PH-6Y	1
XP5	996510012698	HS 6P PH-6Y/JC20-6Y 150MM	1
XP6	996510010961	8PIN CABLE WITCH SHIELD	1
XS302	996510004064	CABLE 2P HS L=160MM	1

REVISION LIST

Version 1.0

* Initial release